



CREATOR[®]
Professional Audio-Visual Manufacturer







PGMIII Programmable Ethernet Control System
User Manual
V1.2

CREATOR CORPORATION

Meaning of the symbols

■ Safety Instruction

Symbols are used in the Manual and devices, referring to the possible risk to users or others, as well as the damage to property, for helping you to safely and properly use the devices. The instruction and the implications are as follows. Please make sure your correct understanding of these instructions before using the Manual.

| | |
|---|--|
|  | <p>To remind user to conduct according to the attached operation and maintenance instructions. If ignore these information, death or injury could possibly happen.</p> |
|  | <p>To remind the user that the risky uninsulated voltage in the device could caused electric shock to human.</p> |
|  | <p>CE authentication indicates the product is in line with the EU safety regulation, and for assurance of safety use.</p> |
|  | <p>SGS Authentication indicates the product has reached the QC standard of the global-biggest Swiss universe surveyor.</p> |
|  | <p>This product has acquired the ISO9001 International Quality Authentication (Authentication authority: Germany Rheinland TUV)</p> |
|  | <p>Caution: To avoid electric shock, please don't open the case, nor put the useless parts in it. Please contact with qualified service staff.</p> |

■ General Information Instruction

| | |
|---|--|
|  | <p>List the situation of causing unsuccessful operation or setup, and relevant information needed to notice.</p> |
|---|--|

Important Notices



Caution

To ensure the device in reliable use and personal safety, please abide by the following items when in installation, use and maintenance:

Notice in installation

◆ Please DO NOT use the product in following places: the places with dust, oily smoke, electrical conductive dust, corrosive gas, inflammable gas; the places with high temperature, due, rain and wind exposures; the places endangered by shock and vibration. Electric shock, fire and incorrect operation could also cause damage and deterioration to the product.

◆ When conducting screw drilling and wiring process, DO NOT let metal irons and wire lead drop into the controller and air vent, which could possibly cause fire, failure and accidental operation.

◆ After finishing the installation, it is necessary to ensure there is no foreign matter including the packing material like contact paper on the ventilation surface, otherwise, it could cause poor heat dissipation while running, as well as fire, failure and accidental operation.

◆ Avoid conducting wiring and plugging in/out cable socket with electricity, otherwise, electric shock, circuit damage could easily happen.

◆ Installation and wiring should be firm and reliable. Poor contact could cause malfunction.

◆ With regard to the application situations with strong interference, shielded cable should be used for the input and output of HF signal, to improve the anti-interference performance of the system.

Note in Wiring

◆ Installation and wiring shouldn't be conducted until external electric power is cut off, otherwise, electric shock or device damage could happen.

◆ The product is grounded by the earth lead of the power cable. To avoid electric shock, the earth lead is necessary to be connected with the ground. Before making connection with the output end or input end of the product, please ensure it is correctly grounding.

◆ Upon finish wiring, remove the sundries. Please cover up the terminal plate for avoiding electric shock.

Note for Operation and Maintenance

◆ Please DO NOT touch the terminal when with electricity, otherwise, electric shock could happen.

◆ Don't clean up and screw the terminal tight before power is off. Such operation could cause electric shock when with electricity.

◆ Please turn off the power before connecting or disconnecting the communication signal cable, peripheral modules or control units, otherwise, device could be damaged and accidental operation could happen.

◆ Please DO NOT disassemble the device, so as to avoid internal electric components damage.

◆ It is necessary to read through the Manual and fully ensure the safety, before altering the program, trial running, starting and stopping operation.

Note for declaration of the worthless

When declaring of worthless, please note

- ◆ Explosion of electrolytic capacitor on the circuit board could happen when burning it.

- ◆ Please classify and dispose it. Don't dispose it into household garbage.

- ◆ Please deal it as industrial waste, or in accordance with local environmental protection regulation.

Forward

User's Manual for PGMIII Programmable Ethernet Control System mainly introduces the operation manner, primary parameters and trouble shootings of PGMIII.

The Manual serves as user's operation instruction only, rather than for maintenance service purpose. Since the date of release, any function or relevant parameter alteration will be provided in supplement instruction. Please refer to the manufacturer or dealers for inquiry.

CREATOR Electronics own the copyright of the Manual. Without permission, any unit or person shall not take part or total of the Manual for business purpose.

The copyright of the Manual is protected by Copyright Law of People's Republic of China and other Intellectual Property Law. Without written permission, any copy or distribution is prohibited.

Index

| | |
|--|----|
| Chapter One ,General Introduction..... | 1 |
| 1.1 Main Features..... | 1 |
| 1.2 Controller Installation..... | 1 |
| Chapter Two,Detailed Controller Specifications..... | 2 |
| 2.1 Front & the rear Panel..... | 2 |
| 2.2 Interfaces Introduction..... | 4 |
| 2.2.1 COM Pins introduction..... | 4 |
| 2.2.2 CR-NET Connection..... | 4 |
| 2.2.3 CR-LINK Connection..... | 4 |
| 2.2.4 USB Interface..... | 4 |
| 2.2.5 Change the controller's MAC address..... | 5 |
| Chapter Three,Receiver..... | 6 |
| 3.1 CR-WF10 Wireless Access Point..... | 6 |
| 3.1.1 CR-WF10 Settings..... | 7 |
| 3.1.2 System Connection Diagram..... | 12 |
| 3.1.3 Cascading and Ethernet Connection Diagram..... | 13 |
| 3.2 Wireless One-way Receiver: CR-RFA..... | 13 |
| 3.2.1 How to use..... | 13 |
| Chapter Four,Connection Diagram..... | 14 |
| 4.1 System Connection Diagram..... | 14 |
| Chapter Five,IR Emitting Probe..... | 15 |
| 5.1 Features..... | 15 |
| 5.2 Connection instruction..... | 15 |
| Chapter Six,Extension Cards..... | 16 |
| 6.1 D/A Conversion Card..... | 16 |
| 6.1.1 Features..... | 16 |
| 6.1.2 External Input..... | 16 |
| 6.1.3 Operation Instructions..... | 16 |
| Chapter,Software Introduction..... | 18 |
| 7.1 Think Control 1.0 Programming Software..... | 18 |
| 7.2 Think Control 1.0 Installation..... | 18 |
| 7.3 jdk1.4 Installation..... | 19 |
| 7.4 Set up the correct path jdk..... | 20 |

| | | |
|-------|---|----|
| 7.5 | Uninstallation..... | 21 |
| 7.6 | Codes organization and Controller Functions..... | 21 |
| 7.6.1 | Codes Organization..... | 21 |
| 7.6.2 | Controller Functions..... | 23 |
| 7.7 | Programing..... | 29 |
| 7.7.1 | Build a new project..... | 29 |
| 7.7.2 | Add device..... | 29 |
| 7.7.3 | Add event..... | 31 |
| 7.7.4 | IR Learning..... | 32 |
| 7.7.5 | Import IR Control Codes..... | 35 |
| 7.7.6 | Editing the program..... | 36 |
| 7.7.7 | Compile the project..... | 37 |
| 7.8 | Upload the program to the CR-PGMIII..... | 37 |
| 7.9 | Project Sample..... | 38 |
| 7.9.1 | Control the built-in relay modules on the controller..... | 38 |
| 7.9.2 | Cascading and Module calls..... | 39 |
| 7.9.3 | Wall-mounted Programmable keyboard..... | 41 |
| 7.9.4 | Lighting and Sound Control..... | 42 |
| 7.9.5 | Interlock of 2 ways relay..... | 43 |
| 7.9.6 | Repeat button pressing without affecting delay timer execution..... | 43 |
| 7.9.7 | Control the matrix switchers..... | 44 |
| | Chapter Eight, Technical Specifications..... | 46 |
| | Chapter Nine, General Trouble Shootings..... | 47 |

Chapter One ,General Introduction

CR-PGMIII is a patent Programmable Ethernet Controller launched by CREAOTOR. It has applied 32bit 667MHz ARM11 CPU, 256M RAM, and 1G Flash Memory.

The CR-PGMIII Programmable Ethernet Controller provides multi-types controlling interfaces: 3 types of network controlling ports: CR-NET, CR-LINK and Ethernet; IR, I/O, RELAY, and COM Ports, etc.

Advanced IC Technology has been applied to provide high-speed accurate integrated control; and the Open Programming UI ensures the easiness of programming for various complicated controlling functions.

1.1 Main Features

- ◆ Elegant design integrated with both popularity and fashion
- ◆ ARM11 CPU,256M DDR RAM,1G Flash Memory;
- ◆ 667MHz 32bit powerful CPU;
- ◆ 8 independent programmable IR Control modules, supporting multiple same or different equipment through IR;
- ◆ 8 independent programmable RS-232/422/485 Controlling interfaces; allowing users to program and set multiple types of controlling protocols and codes
- ◆ 8 low-current replay modules;
- ◆ 8 digital I/O Modules

- ◆ 3 types of network communication: CR-NET,CR-Link,Ethernet;

- ◆ USB2.0 programming communication interface;

- ◆ built-in IR Learning module, easy for diagnosing and maintenance;

- ◆ both local and remote control supported;

- ◆ Universal power (AC100~240V) ,

1.2 Controller Installation

The CR-PGMIII programmable Ethernet Controller can be installed onto standard 19 inch rack. One pair of racking frames has been provided along with the machine. Please refer to the following draft for the guidance:

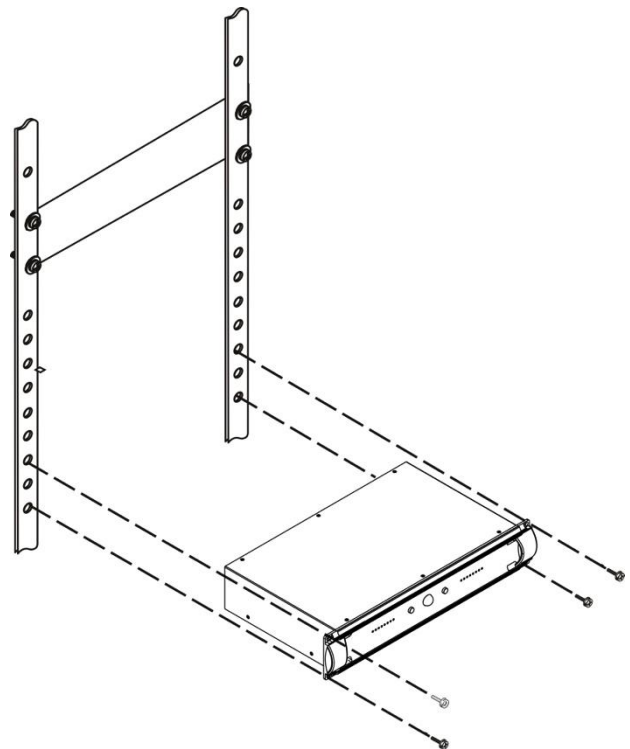

Chapter Two, Detailed Controller Specifications

2.1 Front & the rear Panel

CR-PGMIII Front Panel:

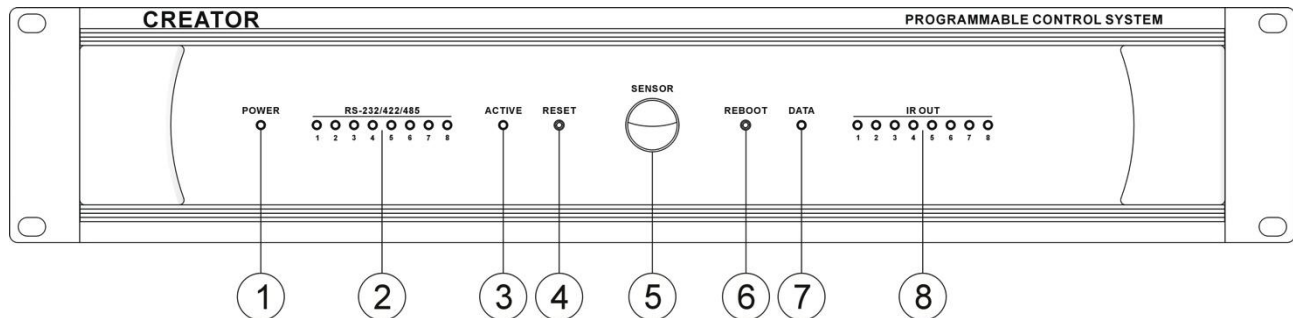

CR-PGMIII Rear Panel:

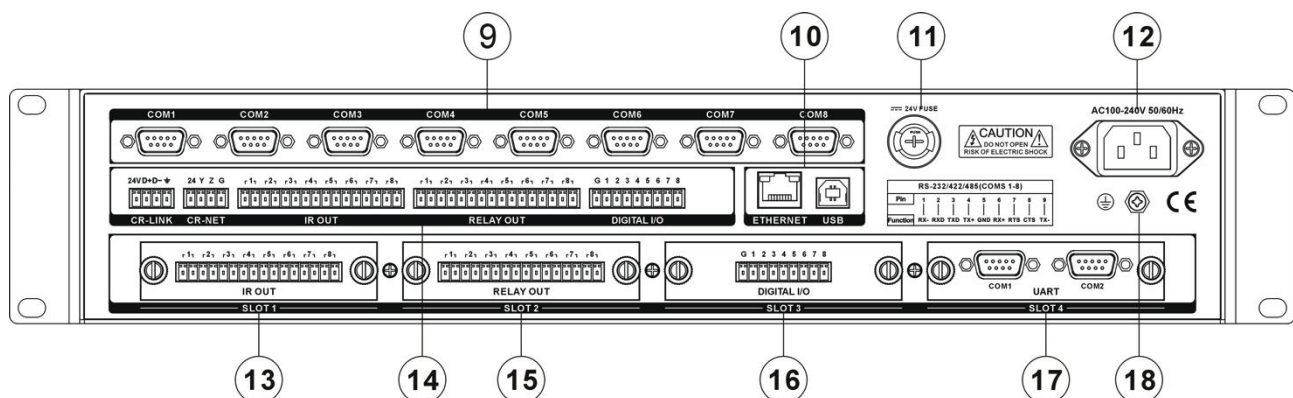

1) **POWER**——Power Indicator

2) **RS-232/422/485**——COM data communication indicator

Indicates the data communication status of the 8 COM interfaces: when there is data sending or receiving, the corresponding indicator will be on. The “TX” is for data sending indication, and the “RX” is for data receiving indication.

3) **ACTIVE**——Status Indicator

4) **RESET**——Reset Button

When the controller is into an abnormal status

due to being downloaded with wrong program (a infinite loop for example), the RESET button can be pressed to erase the wrong program.

Operation Instruction: First power off the controller; then power on the controller while press and hold the RESET button. The “beep” sound will start and continue. Release the RESET button after about 7 ~8 beeps, and the wrong program will be erased from the controller.

5) **SENSOR**——IR Receiving Window

CR-PGMIII Programmable Ethernet Controller provided built-in IR Learning Module, and SENSOR can receiving the IR Signal to be

learned for controlling.

6) **REBOOT**— Reboot button

Press this button to reboot the system when the controller is not functioning.

7) **DATA**— Data Signal Indicator

The indicator will be ON if the data signal transmission is normal, or, it will be OFF

8) **IR OUT**— IR Signal Indicator

Indicating 8 IR Modules status: when the controller is sending the IR Control Signal to the equipment to be controlled, the corresponding indicator will be ON.

9) **COM Interfaces**

8 programmable two-way serial communication DB9 (male) interfaces have been provided; RS-232/422/485 protocols.

10) **ETHERNET**— Ethernet Interface

Used to communicated with the Ethernet and the Wifi touch panels, or to realize the Ethernet remote control.

USB—USB2.0 Communication Interface

Connected to the PC's USB interface to realize various operations: such as the program downloading, System Diagnosis, and IR Learning, etc.

11) **24V Safety**

12) **AC 100V~240V**— System Power Supply

Power Supply for the controller: self-adaptive AC100V~240V@ 50/60H.

13) **IR OUT**— Extension IR Control Module Slot

Extension IR Control Module can be inserted here to extend the total IR Control Modules.

14) **CR-LINK**—CREATOR High-speed Bus Interface, for extending controlling functions

CR-NET—CR-NET Bus

CREATOR Communication Interface (Similar to RS485) of 4-core phoenix connector type; can be used to connecting various CREATOR external network equipment: such as the relay box, lighting control module, sound control module, wireless Access Point, and wired touch panels, etc.

IR OUT—IR Control Port

Includes 8 ways independent programmable IR Control carrier waves to control various equipment: such as the DVD, VCR, and MD, etc. It's of the 2-core phoenix connector type, and needs to be used along with the IR Emitting Probes: connect the IR Emitting Probe to the IR OUT port and the other end near to the equipment to be controlled (the distance needs to be $\leq 15\text{cm}$).

RELAY OUT—Low-current Relay Control Port

Provides 8 ways low-current control function, and can drive the load below AC 0.3A/125V and DC 0.3A/110V, DC 1A/30V. It can control the ON and OFF of any equipment fulfilling the above mentioned conditions to realize controlling high-current, high-voltage load with low-current, low-voltage controller

DIGITAL I/O—I/O (input / output) interface

Provides 8 ways programmable I/O controlling function: 5V/10mA output or 0~5V/10mA input.

15) **RELAY OUT**—Extension Low-current Relay Module Slot

Can extend the low-current relay module number by inserting extension module.

16) DIGITAL I/O—Extension I/O Module Slot

Can extend the I/O control module number by inserting the extension module here.

17) UART— Extension COM Module Slot

Can extend the COM interface number by inserting the extension COM module here.

18) Grounding Pole

2.2 Interfaces Introduction

2.2.1 COM Pins introduction

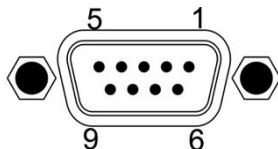

| Pin | Signal | Introduction |
|-----|--------|--|
| 1 | RXD | RS-485 protocol, connected along with the pin 9 to be used as the RS-485"-." |
| 2 | RXD | RS-232 protocol, receive data |
| 3 | TXD | RS-232 protocol, send data |
| 4 | TXD+ | RS-485 protocol, connected along with the pin 6 to be used as the RS-485"+." |
| 5 | GND | Signal Grounding |
| 6 | RXD+ | RS-485 protocol, connected along with the pin 4 to be used as the RS-485"+." |
| 7 | RTS | RS-232 protocol, request for sending |
| 8 | CTS | RS-232 protocol, cancel sending |
| 9 | TXD | RS-485 protocol, connected along with the pin 1 to be used as the RS-485"-." |

2.2.2 CR-NET Connection

The connection of the CR-NET equipment supports both series and parallel connection types. And attention should be paid to the corresponding of the 24,Y,Z,G. Please refer

to the following diagram:

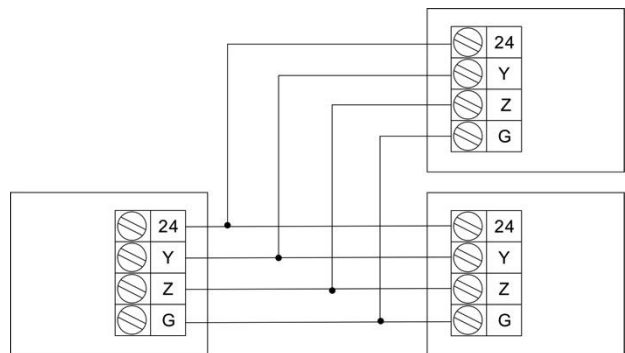

During the installation and using, plugging and unplugging equipment while power is ON should be avoided to reduce the risk of malfunction of the controller due to the electric shock caused.

2.2.3 CR-LINK Connection

The connection of the CR-NET equipment supports both series and parallel connection types. And attention should be paid to the corresponding of the 24,D+,D-,⊥. Please refer to the following diagram:

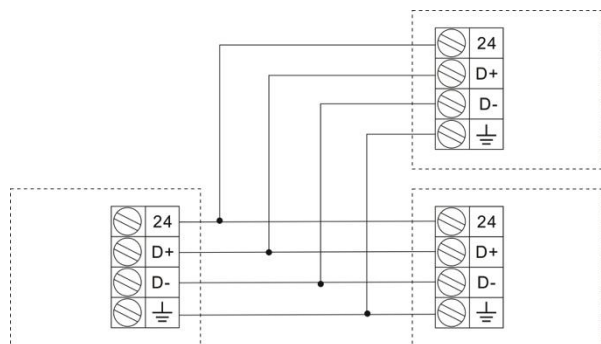

During the installation and using, plugging and unplugging equipment while power is ON should be avoided to reduce the risk of malfunction of the controller due to the electric shock caused.

2.2.4 USB Interface

The USB interface is used to communicate with the PC during programming and diagnosis. The connection diagram is as following:

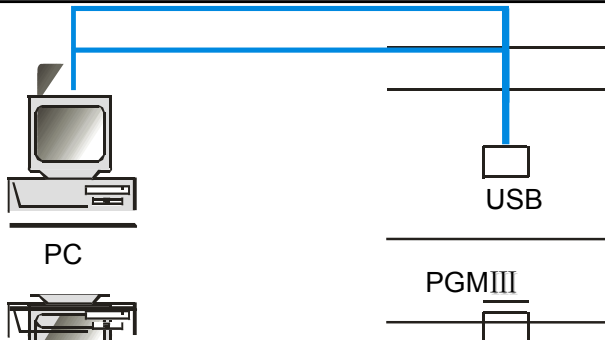

2.2.5 Change the controller's MAC address

The MAC address cannot be in conflict with any equipment's MAC address (the PC for example); and it needs to be modified if the conflict happens.

How to do it: While ensuring the controller is in good communication with the PC, fill in the MAC address in the box according to the following sample. Then click the OK and reboot the controller.

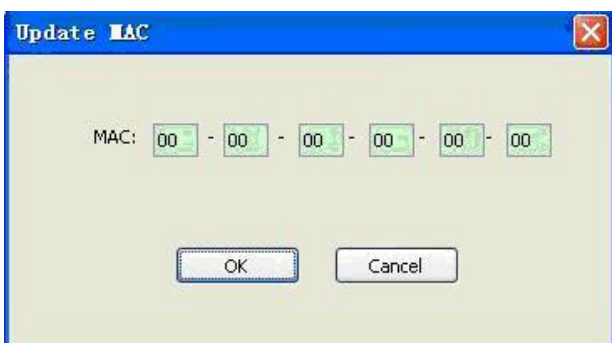

Chapter Three, Receiver

3.1 CR-WF10 Wireless Access

Point

The CR-WF10 is a wireless router with delicate, elegant design.

The wireless AP provides the communication between the CR-PGMIII and CREATOR Wifi wireless touch panels to ensure the easy, flexible and highly effective control experience.

Features

- ◆ Resistible to 12KV static electric shock
- ◆ WEP 64bit/128bit digital encryption technology has been applied to ensure the stableness and confidentiality of the transmission to avoid tapping and interference.
- ◆ One RJ45 interface has been provided for the connection to the CR-PGMIII or Network Switch. High-quality CAT5 cable is recommended.
- ◆ Configuration Mode: AP Mode, Point to Point Bridge Mode and Point to Multiple Point Bridge Mode.
- ◆ The signal coverage can reach up to a circle area of 15 meters radius without strong block. The general coverage is a circle area of 10meters radius
- ◆ IEEE802.11g, IEEE802.11b standards supported;
- ◆ Dual-antenna to ensure the stableness of transmission

Interfaces:

Front Panel:

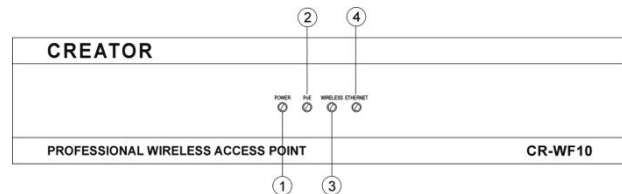

Rear Panel:

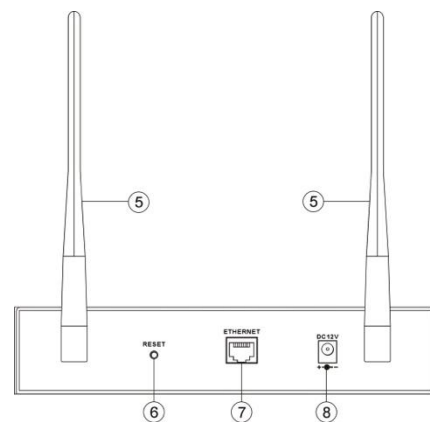

① POWER

Power indicator: it will be ON if the device is powered on, otherwise it will be off.

② PoE

Ethernet power supply indicator: when the Ethernet powers the device, it will be on.

③ WIRELESS

Wireless network signal indicator: when there is wireless signal transmitting, the indicator will on, meaning it is sending or receiving data.

④ ETHERNET

Ethernet signal indicator: when there is Ethernet signal transmitting, the indicator will on, meaning it is sending or receiving data.

⑤ Antenna

A pair of rotatable antenna has been provided for

being adjusted for best signal transmission

⑥ RESET

This is the reset button. There are two ways of reset the device to the default settings: press and hold the RESET button for 10 seconds, or, use the web-browser based configuration tools.



The RESET button will eliminate all the settings back to the default settings, which include all the security settings and IP. The default value will be: IP: 192.168.1.245, login user name: admin, Password: admin.

⑦ ETHERNET

Ethernet interface, for connection to network card, network switch or routers. The blue color means the connection is good, while the orange color means the communication is going on.

⑧ DC 12V

DC power supply interface: the device is powered by DC 12V.

3.1.1 CR-WF10 Settings

Step One: Hardware installation

Connect the CR-WIFI10's ETHERNET port to the PC's network card, and connect the power supply to the CR-WIFI 10. Then the device should be on automatically.

Step Two: Set the right IP

The default IP of the CR-WF10 is: 192.168.1.245, the default subnet mask is: 255.255.255.0, and the default SSID is ciscosb, all of which can be set to other value required.

1. Wired Network settings (example given in Windows XP OS)

Power on the PC with Windows XP installed and check whether the LAN port indicator is ON. If not, please check and make sure the PC is well connected to the router.

Firstly, right click on the desktop and choose the "Network Neighbor" from the popup menu, then choose and click "Prosperities". Illustrated as Img. 3-1.



Img.3-1

Right click the "Local Connections" on the opened window and click the "Properties" as shown in Img. 3-2.

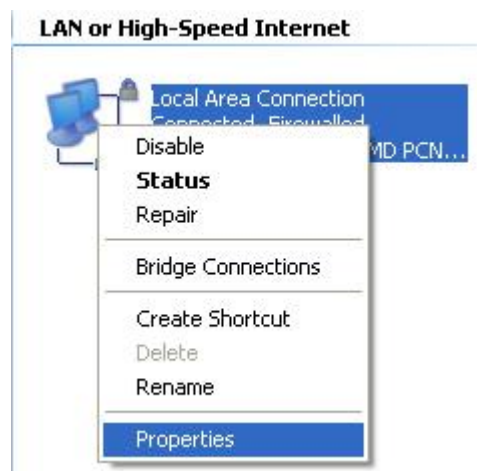

Img. 3-2

Choose the "Internet Protocols (TCP/IP)" at the popup dialog, as shown in the Img. 3-2. Then right click and choose "Prosperities".

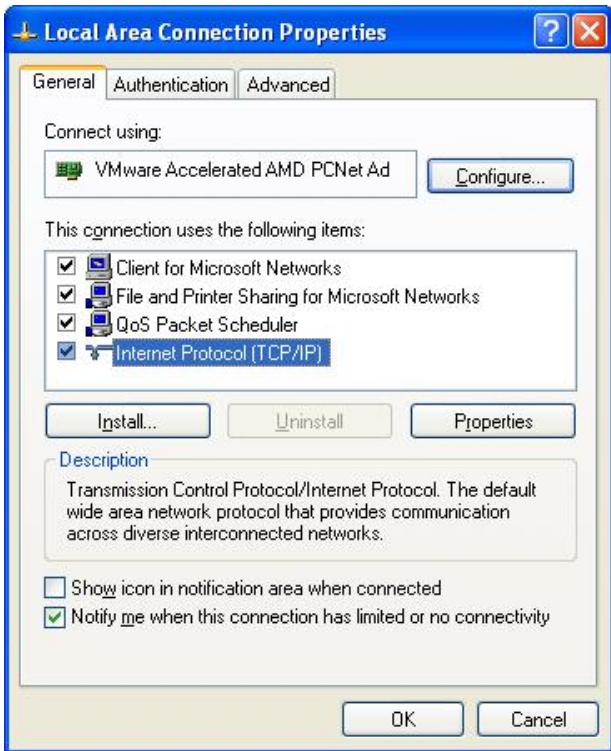

Img.3-3

Then, set the IP, Subnet Mask and the Default Gateway in the window opened. The IP address should be within 192.168.1.1 to 192.168.1.254(192.168.1.245 excluded). The Subnet Mask is: 255.255.255.0, and the default Gateway is: 192.168.1.245. Click "OK" to save the prosperities of the Local Connections, as shown in Img. 3-4:

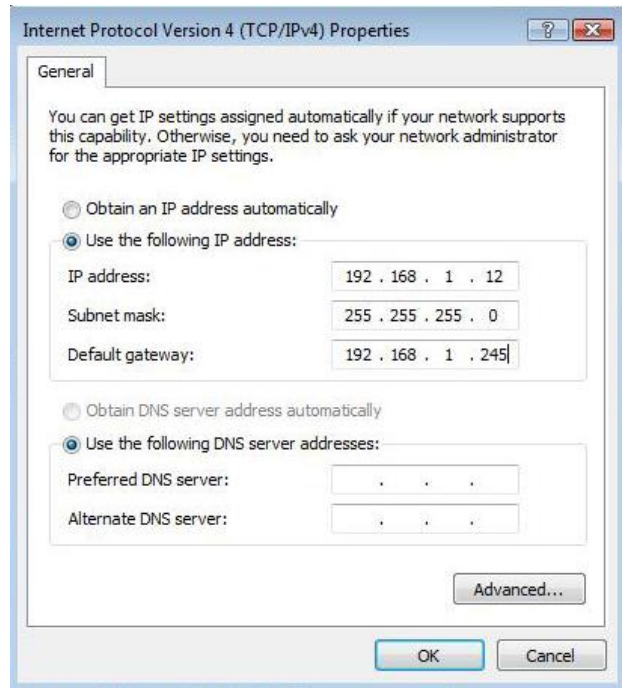

Img. 3-4

2. Verify the settings (based on Windows XP OS) Select: "Start" --- "All Programs" --- "Accessories", as shown in Img. 3-5:

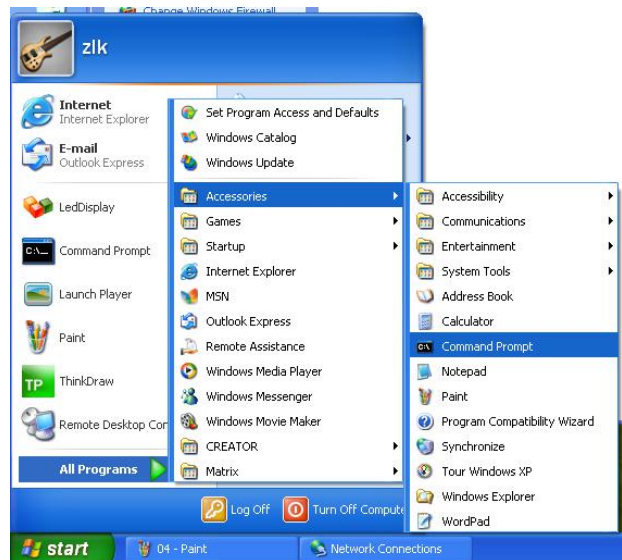

Img. 3-5

Follow the instructions shown in Img.3-6, type "Ping 192.168.1.245" and press Enter. If you can get the results as shown in the image, it means the connection between the PC and the CR-WIFI 10 is working.

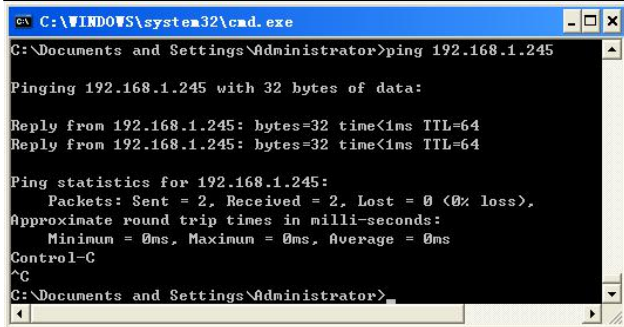

Img.3-6

3. Log in the CR-WIFI 10 (based on Windows XP OS)

Open IE browser, and type 192.168.1.245 into the address bar, then press Enter, as shown in the Img. 3-7:



Img. 3-7

Use the username: admin (default) and the password: admin (default) to log in at the pop up window, and press Enter, as shown in the Img. 3-8:



Img. 3-8

Step Three: Wireless Settings

The settings page of the CR-WIFI 10 will open after procedures shown in Img. 308, and the page is as shown in Img. 3-9, which includes setting options as: Setup Wireless AP Mode Security

Monitor, Administration, and Status. What need to be changed are only the Setup, Wireless, and the Administration.



Img. 3-9

3.1.1.1 Setup

Basic settings and network settings can be down under this option. The interface is as shown in Img. 3-4.

◆ **Basic Setup**

Basic Setting: to perform settings of Host name and Device Name. The Host Name can be used to access the network, and build up the DNS through the network.

Host name: Set the controller’s name. A proper name is suggested for easier manage.

Device Name: Set the device’s name: it can be any name.

◆ **Network Setup**

Network settings: IP can be changed under this option.

IP Settings: Set up the law for IP assignment: static or dynamic. The default way is static IP, and the same default value should be kept for the controller’s settings. The CR-WIFI 10’s IP can be changed by the following procedures:

Local IP Address: fill in your IP address,

e.g.: 192.168.2.1

Subnet Mask: fill in the Subnet Mask, such as: 255.255.255.0

Except the above mentioned settings, all the other value can be set as 0, which include Default Gateway, Primary DNS and the Secondary DNS. Click "Save Setting" to save and finish the settings.

3.1.1.2 Wireless Settings



Img. 3-10

The wireless setup page is shown in Img. 3-10. For setting up the wireless network the control system, only the following items should be changed, while other items should be kept as their default value.

1, Basic Wireless Settings

Basic Settings: to setup the basic prosperities of the wireless network.

Wireless Network Mode: the following options are available:

Disable: to disable the wireless connections

B-Only: B Mode: the max speed of the wireless transmission is 11Mbps.

G-Only: G Mode: the max speed of the

wireless transmission is 54Mbps

Mixed: Self-adaptive mode

This option is recommended, then the device can self-adjust and choose the best suitable mode according to the network card connected.

Wireless Channel: Choose the right channel here. The default amount of the channels is 6. For the detailed settings, please refer to Section 3.1.1.3 in this chapter.

SSID Name: The log in name used for wireless local network identification. Only the ID passed the identification can access the wireless network. As shown in the image, this device supports 4 SSID, and the SSID name can be customized.

SSID Broadcast: Enable should be set here for the other devices to detect the AP. Click "Save Settings" to finish the settings.

2, Wireless Security Settings

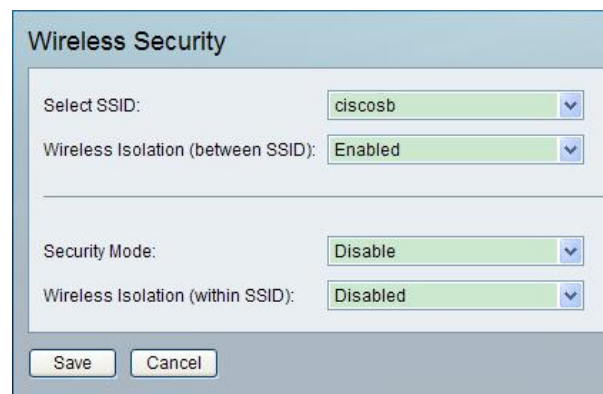

Img. 3-11

Wireless Security: Security parameters can be set here: set a key and enable WEP, or WPA, WPA2 encryption to reject the unauthorized access to the network. As shown in Img. 3-12.

Select SSID: select an SSID and set its security mode. The image shows the security

settings for "ciscosb".

Wireless Isolation (between SSID): when it is enabled, different users within different SSID cannot access each other to realize Wireless Virtual Local Network. The default value is Enable, and to improve the security level, it is recommended to enable this option.

Wireless Isolation (within SSID): Clients within this AP cannot access each other when it is enabled, which can prevent the spreading of virus. The default value is disabled.

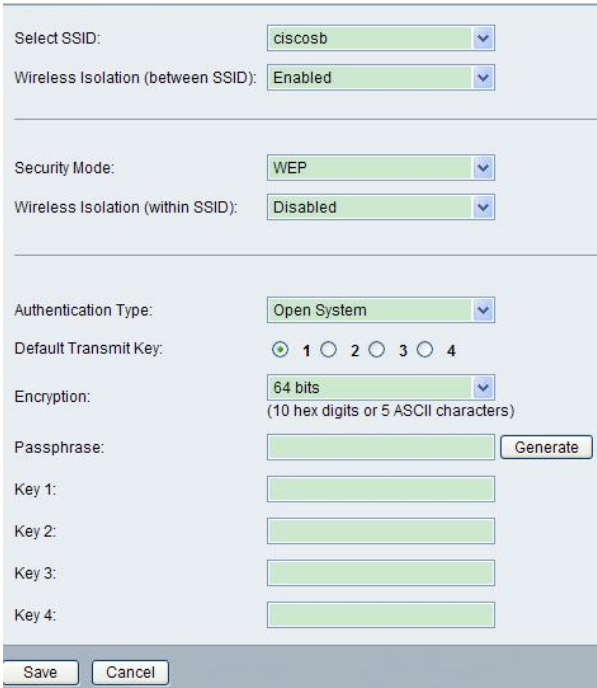
Security Mode: 9 different encryption methods are provided for this AP. The WEP mode is recommended, as shown in :

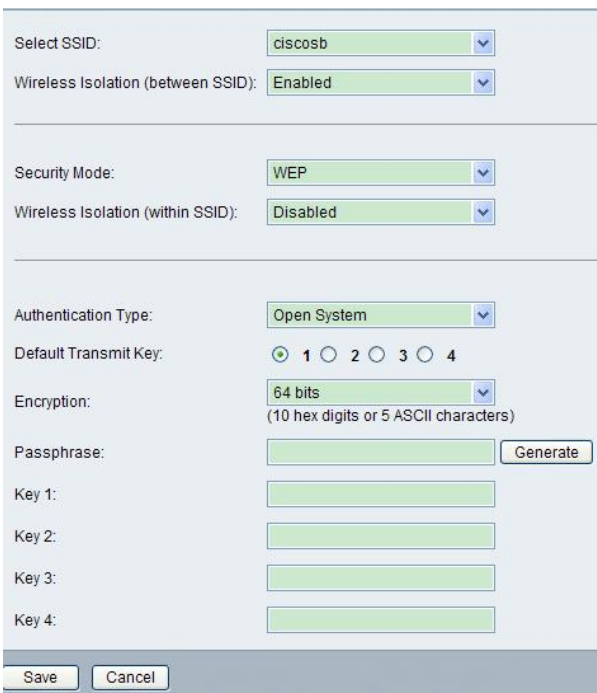

Img. 3-12

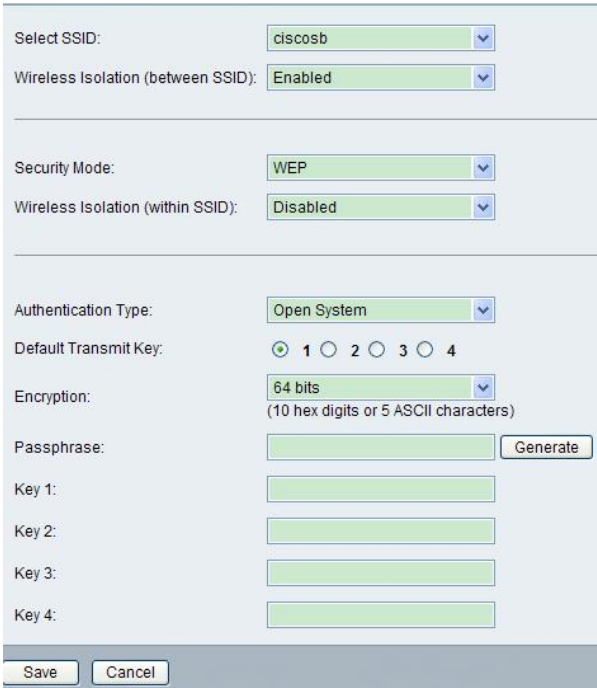
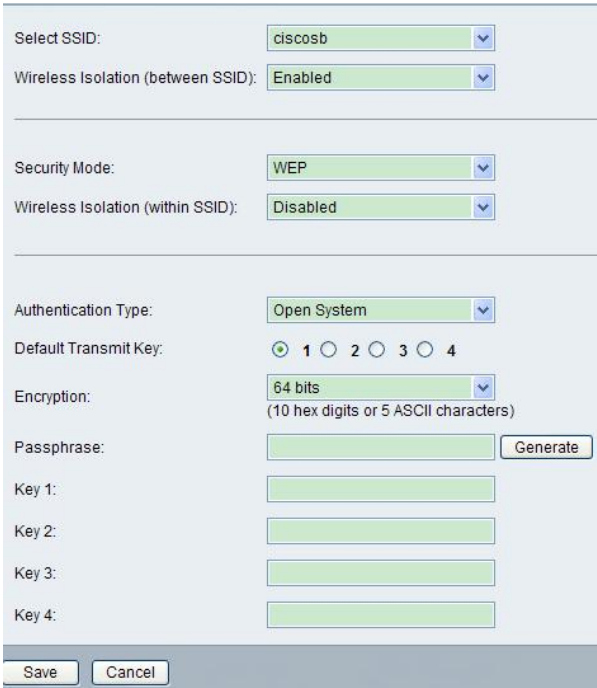
Authentication Type: Nothing needs to be changed here. The default value is open system, which is a hand-shaking method for WEP encryption. The setting is shown as following:   3-13

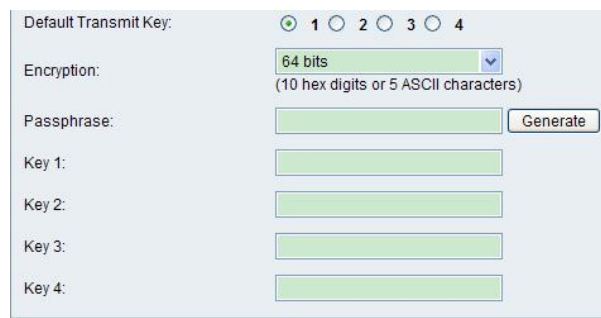

Img. 3-13

The available key is from 1 ~ 4, and definition can be made to the 4 keys respectively. All the four

keys can be used to access the AP. There are two types of Keys: Hex and ASCII: the key needs to be 0 ~ 9 for the Hex format, and all the characters can be used for the ASCII format.

Default Transmit Key: Default key, and corresponds to the following Key 1 to Key 4.

Encryption: The way of encryption: the default is 64bits: input 10 bits Hex characters or 5 bit ASCII characters in the corresponding transmit key. If 128bits format has been chosen, then 26bits characters or 13 ASCII characters are required for the Keys.

Passphrase: Use this to generate password by the system. It is not recommended to be used, in stead, use your own memorable keys.

3.1.1.3 Wireless Channel Setting Rules

The following aspects should be paid attention to while setting the Wireless Channel:

1. Wireless PCs are based on WiFi802.11g or 802.11b standards, and 13 overlapping channels are provided in wireless PC network, as shown in the following image:

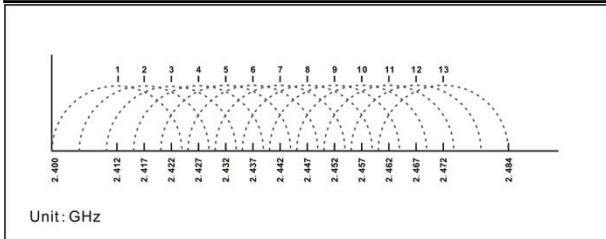

Img. 3-14

2. Pay attention to the carrier wave: in the system, the provided 13 overlapping channels in wireless PC network have been divided into 3 groups, as shown in the following image:

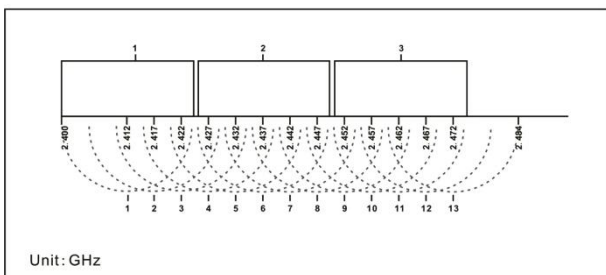

Img. 3-15

3. Pay attention to the interference: the wireless network in the system will interfere the PC wireless network. Thus, it has to be ensured that the CREATOR WiFi is not overlapping the WLAN channels.

For example:

As shown in the following image, the WLAN channel is 9, which is overlapping the group 1 and 2 of the wireless network. Thus, the first channel of the group 0 should be chosen.



图 3-16

3.1.1.4 Administration Settings

Three options are provided here: Management, Web Access and SNMP:

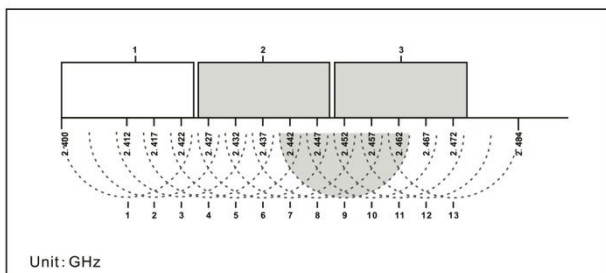

Img. 3-17

Management: it can be reset the user name and password here. It is recommended to reset them for better security condition.

Web Access: To increase the security level, you can use the HTTPS connection type. Set Web HTTPS Access Wireless Web Access as Disabled; Set SNMP as Disabled; Keep other values as default, and click Save Setting to save and finish the settings.

3.1.2 System Connection Diagram

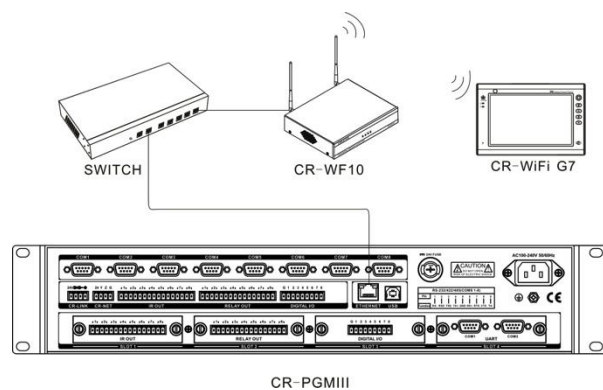

3.1.3 Cascading and Ethernet Connection Diagram

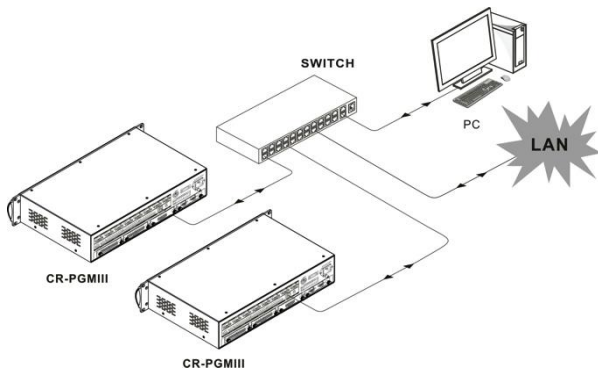

3.2 Wireless One-way Receiver:

CR-RFA

The CR-RFA wireless (RF) one-way receiver provides the connection between the controllers and the one-way programmable touch panels, which works on 433MHz, is of one-way communication.



The ID CODE setting has to be the same as corresponding settings on the controllers, or, they will not be able to communicate.

Interfaces:

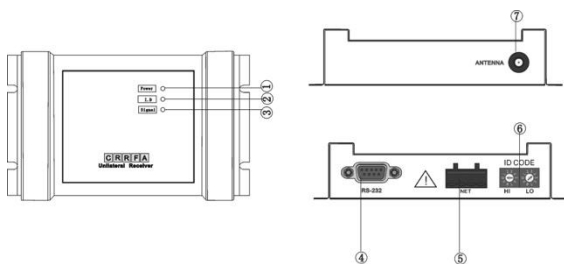

1) **POWER**—Power indicator: will be ON when power supply has been connected

2) **ID**—ID indicator

When the connection is between the CR-RFA and the controller, the ID indicator on the receiver and the NET ID on the controller will be ON.

3) **SIGNAL**—Communication indicator

When the CR-RFA receives the wireless signal from the touch panel, the indicator will be flashing.

4) **RS-232**—Serial Port

Reserved port for the CR-RFA's extension functions.

5) **NET**—4 bit network interface

It is the communication interface between the CR-RFA and the controller, connecting to the CR-NET interface on the controller.

6) **ID CODE**—Network ID

To set the CR-RFA's network ID. Please be noted that the Network ID has to be same as the CR-RFA's ID in the program written by the Control System Builder Software.

7) **ANTENNA**—Spiral antenna

3.2.1 How to use

Generally it is used while the wireless controlling distance is relatively short (within the same room, for example). Besides the remote control, the special PC Serial Port software can be used to enable sending out continuous RF control command from the PC.

Connection:

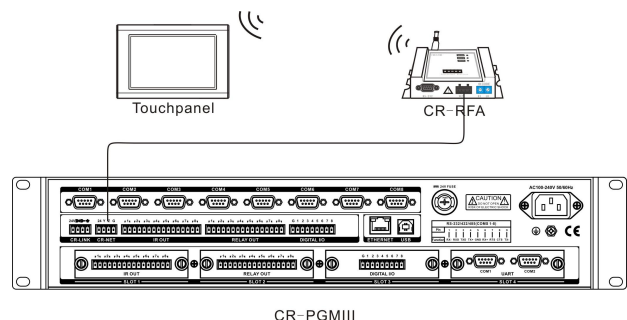

Chapter Four, Connection Diagram

4.1 System Connection Diagram

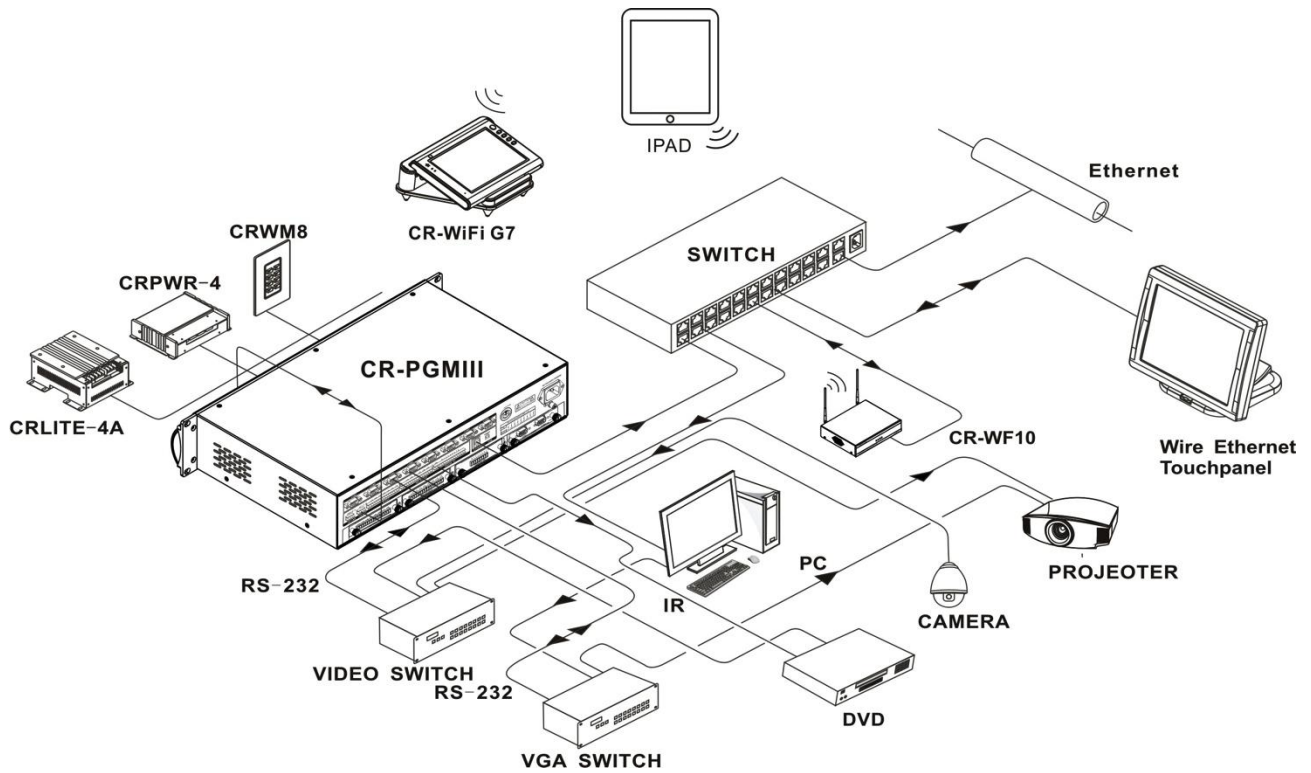

Chapter Five, IR Emitting Probe

5.1 Features

The IR Emitting Probe is mainly used to control the equipment from the controller (such as the DVD, VCR, etc.) It is mainly composed of an IR emitter and a plastic case. The IR emitter has positive and negative. While extension of the Probe cable is required, the "Signal Conductive" property of diode should be paid attention to.

There are many ways to find out the IR control codes:

1. Search from the Think Control Software: within the "User IR Module," which has included most IR Control codes for the equipment on the market.
2. Learn the IR Control code into the program using the built-in IR Learning Module in the controller.

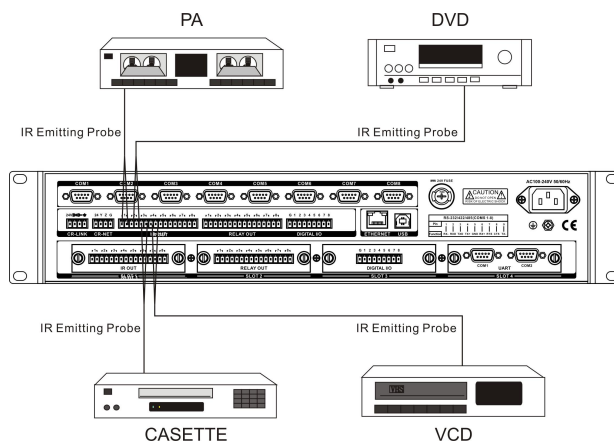

5.2 Connection instruction

Connect the IR Emitting Probe to the IR Module Interface on the controller and stick the other end onto the equipment's IR receiver, or, place the other end within an area of less or equal 45° within 20cm distance from the equipment's IR receiver.

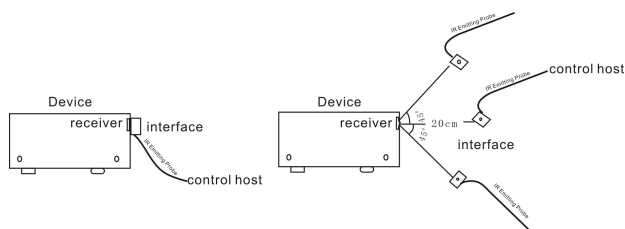

Connection Diagram:

Chapter Six, Extension Cards

6.1 D/A Conversion Card

6.1.1 Features

- ◆ Input: 3 ways high-impedance DC input
- ◆ Output: 3 ways DC output
- ◆ Convert: Convert between Digital and Analog Signals: can be used for sampling and controlling. It is of 10 bit sampling accuracy, and 12 bit output accuracy.
- ◆ Input Voltage Range: 0V ~ +12V
- ◆ Output Voltage Range: -12V ~ +12V
- ◆ The outputted voltage can be adjusted through the software
- ◆ Max input voltage: +36V DC
- ◆ Max Output Current: 5mA

6.1.2 External Input

- ◆ Max Output Sampling Value: +12V
- ◆ Overvoltage: +36V

6.1.3 Operation Instructions

- ◆ How to control the output voltage (D/A Conversion)

The CR-PGMIII controller sends out the commands about the output voltage and channel number to the Conversion Card. After the Conversion Card receives the commands, it will output the corresponding voltage

- ◆ Read the input voltage (A/D Conversion)

The CR-PGMIII controller sends out the commands about which channel's voltage to be

read. After the Conversion Card receives the command, it will read and feedback the actual voltage to the CR-PGMIII.

- ◆ The following is the programming instructions for the CR-PGMIII when using the Conversion Card:

```
SEND_QACAR
```

```
Void SEND_QACAR (String dev, in it channel)
```

Function: Send out the request of the Conversion Card's voltage. After the request being sent out, the Data EVENT of the Conversion Card will be triggered, and the voltage value will be seen there. For the detailed example, please refer to other functions' BYTE_TO_INT.

Parameters

```
dev - : D/A Conversion Card Device  
channel -: The device's channel number
```

Sample

```
Acar_m = M:8:ACAR:192.168.1.20; //Define a  
Conversion Card whose mother board number is  
8
```

```
SEND_QACAR (Acar_m,1); // Read the voltage  
on Acar_m's first channel
```

```
BYTES_TO_INT
```

```
Int BYTES_TO_INT (byte[] b)
```

Function: use the byte array's first 4 bits as an int value.

Returns

```
Return converted int value
```

Sample: The Conversion Card returns data: the actual voltage of the Conversion Card = returned

```
voltage/100.00
DATA_EVENT(mcar,2)
{
    ONDATA()
    {
        double tt =
        BYTES_TO_INT(DATA.Data)/100.0 //when using
        SEND_QACAR to send the request, it triggers
        here.

        SEND_COM(COM,1,DOUBLE_TO_STRING(tt));
    }
}

SEND_ACAR
void SEND_ACAR(String dev,int channel,int val)
```

Function: control the voltage output of the Conversion Card.

Parameters:

dev - : Conversion Card Device

channel - : Device's Channel number

val - : Analog Value (Notice: read value according the actual external equipment. The general value reading range is -12V ~ 12v in double type.)

Example:

```
acar_L = L:7:ACAR:192.168.1.20; //Define ACAR
Device with CRLINK(CAN) number of 7
```

```
SEND_ACAR( acar_L,1,-12);// Send Analog
Value -12 to liit_L's first channel. i.e., set the
Converter Card's output to -12V.
```

Chapter, Software Introduction

7.1 Think Control 1.0

Programming Software

The Think Control 1.0 programming software is designed for programming for the CREATOR third generation controller: the CR-PGMIII.

PC OS Requirements

This programming software can run on Windows XP, VISTA, and WIN7.

7.2 Think Control 1.0 Installation

The Think Control 1.0 programming software is available in the disk in the CR-PGMIII's package. It can also be downloaded from the web address at: <http://www.creator.com.cn>.

The installation procedures are as following:
Double click the installer to launch the installation, as shown in the image:



Click Next:

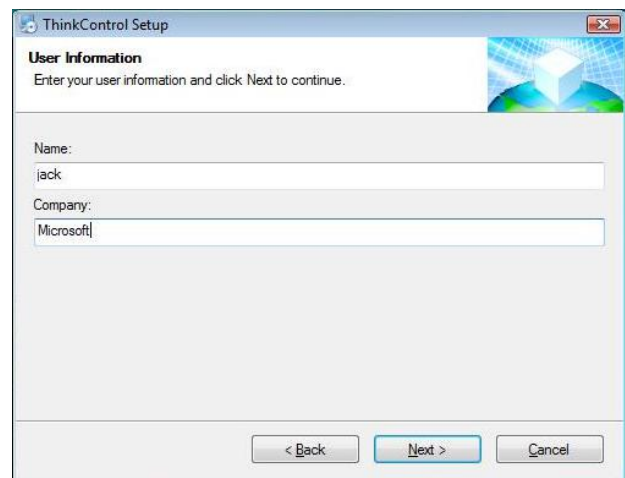

Click Next again.

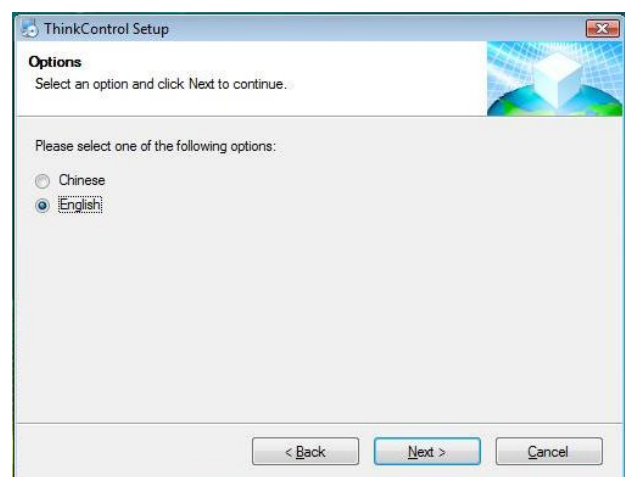

Choose your preferred language, and click Next.

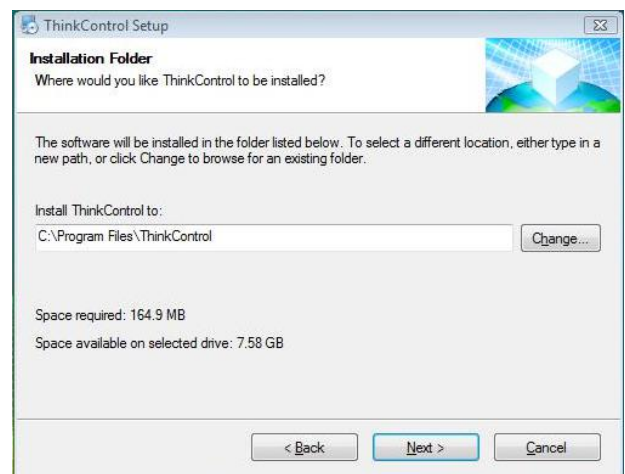

The installation path can be changed by clicking Change. Click *Next* after the installation location has been set.



The installer will show the progress of the installation. Click *Cancel* can abandon the installation.



Type in the shortcut's name, then click *Next*.

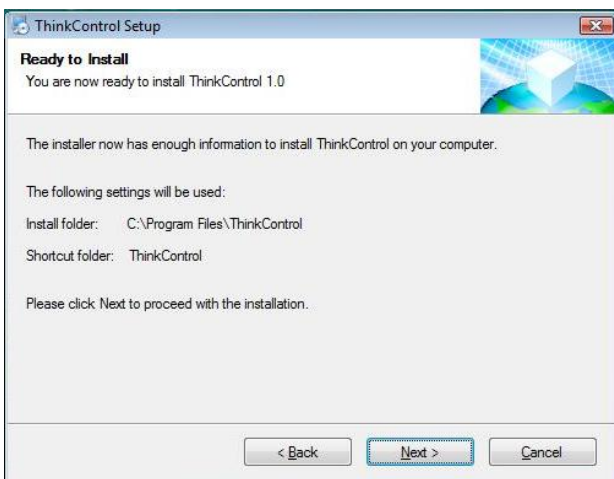

When the installation has finished, click “Finish” to exit. Then, a shortcut icon will be created at the desktop, as shown in the following image:



Make sure the displayed information is correct, then click *Next*.

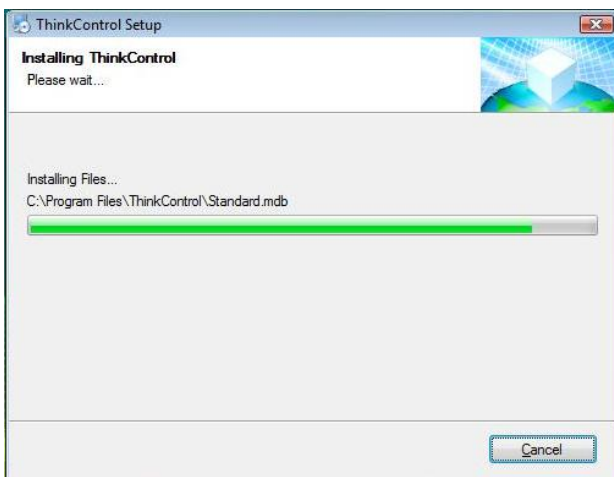

We also need the JDK1.4 to compile the software programmed, or, the following error will appear:

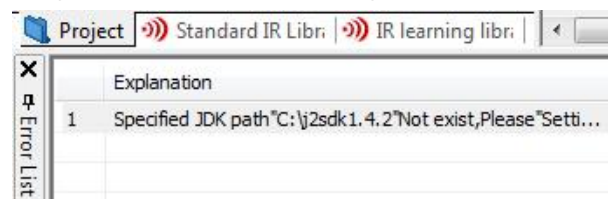

7.3 jdk1.4 Installation

The jdk1.4 software is both available from the disk in the package and the CREATOR. The installation procedures are as following: Click the jdk1.4 installer to launch the installation, as shown in the following image:

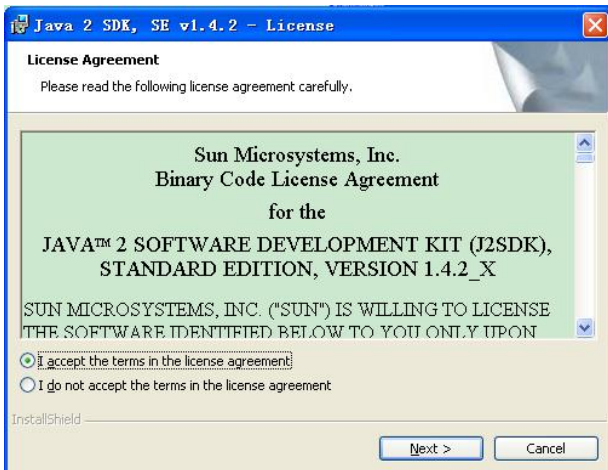

Choose “I accept the terms in the license agreement,” then Click Next

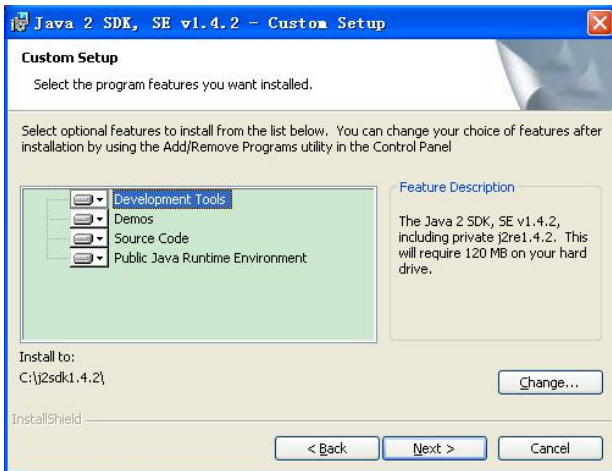
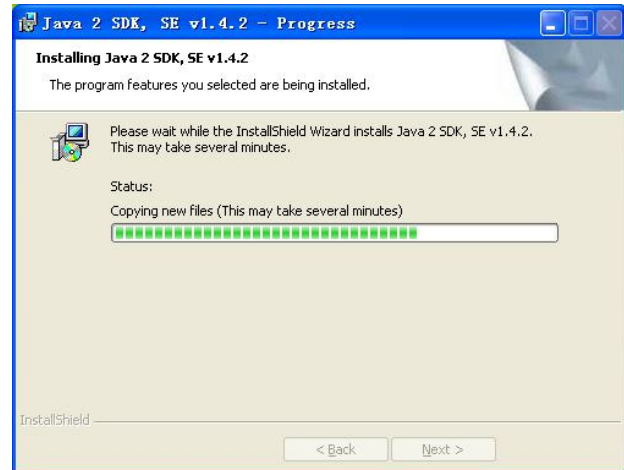

Click Change... to choose your preferred installation path, then click Next

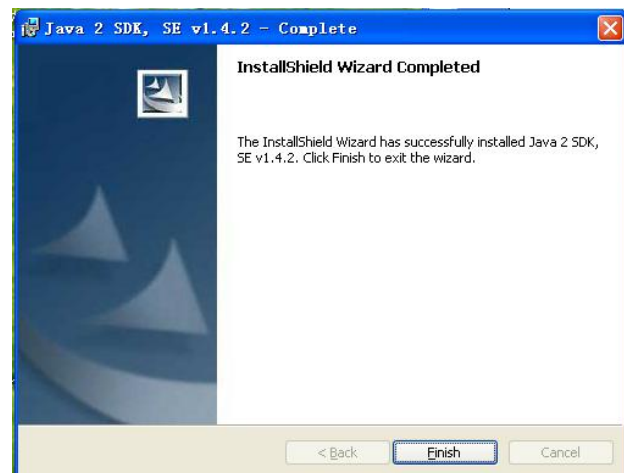

Click Finish to finish the installation.

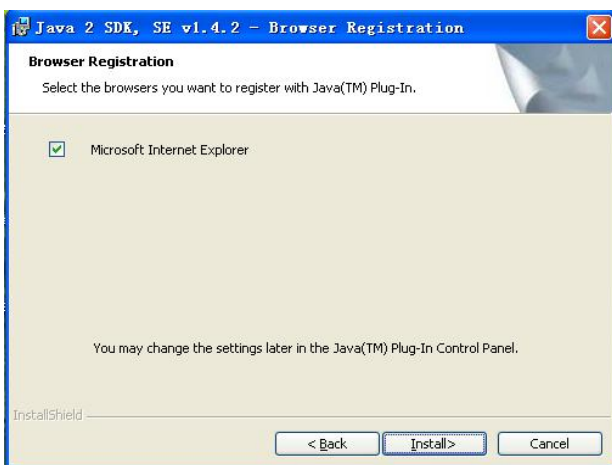

Click Install

7.4 Set up the correct path jdk

After the installation, double click Think Control 1.0's short cut to launch the Think Control 1.0 programming software.

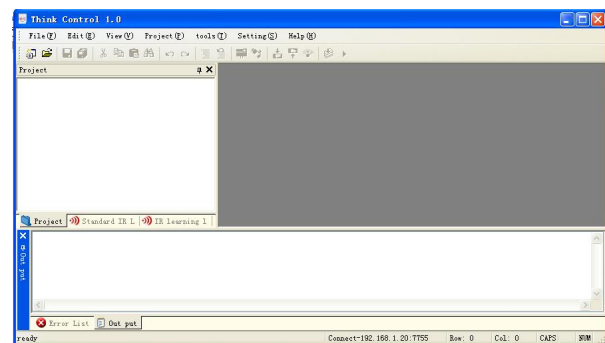

Click “setting” --- “Options” from the menu bar.

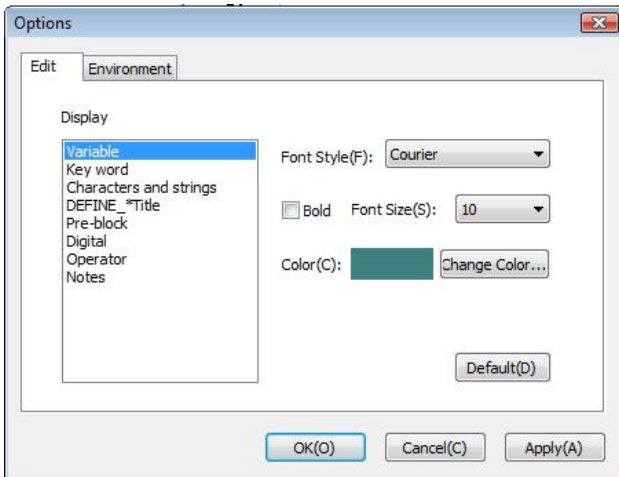

Choose "environment"

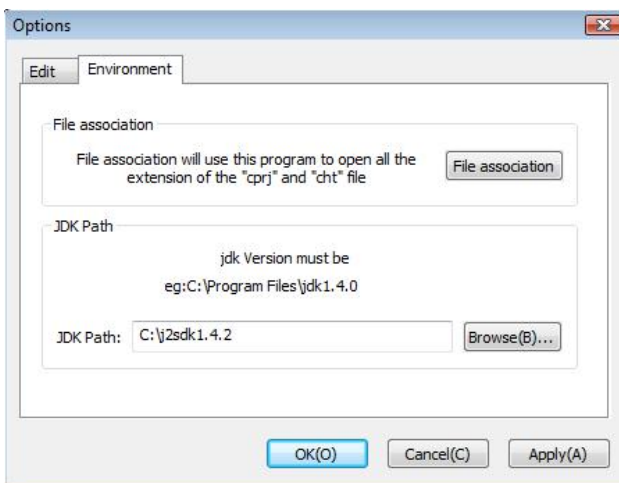

Click to browse the right jdk1.4 installation path.

Note: if jdk1.4's has been installed to its default path, nothing needs to be changed here.

7.5 Uninstallation

The software can be easily uninstalled from "Start"—"Control Panel"—"Add and Delete Program". All files, modules and shortcuts will be deleted after the u installation.

7.6 Codes organization and Controller Functions

7.6.1 Codes Organization

1 A program is consisted of the following modules:

Every module has its own special functions: for example, the "DEFINE_DEVICE" is used to define a device. Each equipment involved in the controlling program has to be defined here. It is recommended not to change the order between every module.

// Device definition module

DEFINE_DEVICE

// Constant define module

DEFINE_CONSTANT

// Variable define module

DEFINE_VARIABLE

// Function define module

DEFINE_FUNCTION

// Program initialization module

DEFINE_START

// Loop define module

DEFINE_PROGRAME

// Event define module

DEFINE_EVENT

2 Define Modules

DEFINE_DEVICE: Device define module

All the device definition has to be done within this module.

DEFINE_COMBINE: Device define module

This module is used to define multiple touch panels in the same system.

DEFINE_VARIABLE: Variable define module

All the variables need to be defined here

DEFINE_CONSTANT: Constant define module

All the constants need to be defined here

DEFINE_FUNCTION: Function define module

All the functions have to be defined here

DEFINE_TIMER: Timer define module

All the timers should be defined here. For some actual requirements, there might need a timer to repeat an action on a regular timer interval.

DEFINE_START: Program Initialization Module

All codes here will be executed first before the other parts in the program. This module can be used to do the initialization jobs, such as initializing variables and execute some initialization operations.

DEFINE_EVENT: Even define module

All the events definition has to be done within this module.

There are mainly three kinds of events:

◆ **Button event**

Syntax: the parameter can be 0, 1, or 2. When there are 2 parameters, it means the even is effective to the defined device name and joint number. When there is only 1 parameter, the event is only effective the defined device name. When the parameter is 0, the event is effective to all the devices.

There functions corresponding to four events: “Press”, “Release”, “Hold” and “the whole button procedure”. The even execution codes have to be put into the corresponding functions.

```
BUTTON_EVENT([device] [JionNumber])
{
    PUSH()
    {
        // The operation to be done when press
        down the button
    }
    RELEASE()

    {
        // The operation to be done when release
        the button
    }
    HOLD(<TIME>[,TRUE|FALSE])
    {
        // The operation to be done after the button
        has been press down and held for a certain, or, at
        a certain time interval.
    }
    REPEAT()

    {
        // The repeatedly operation to be done when
        the button is pressed down.  }
    }
}
```

◆ **Bar Event**

Syntax: the parameter can be 0, 1, 2. When there are 2 parameters, it means the event will only be effective to the defined device and the joint number. When there is 1 parameter, it means the even will be effective to the defined device. When the parameter is 0, it means the event is effective to all devices.

```
LEVEL_EVENT([device] [, Jion Number])
{
    // Operation to be done when the bar has
    changed
}
```

◆ **Data event**

```

DATA_EVENT([device])
{
    ONLINE()
    {
        // Operation to be done when received the
data online command from the device    }
    OFFLINE ( )
    {
        // Operation to be done when received the
data offline command from the device    }
    ONERROR ( )
    {

        // Operation to be done when received the
data error command from the device

    }
    ONDATA()

    {
        // Operation to be done when received the
data from the device    }
}

```

DEFINE_PROGRAME: Loop Module

When the program starts to run, the codes here will be executed repeatedly. Some monitoring operations can be realized here to monitor the device's status.

7.6.2 Controller Functions

Controller functions are used to realize different functions of the controller.

7.6.2.1 SEND_IRCODE

Void
SEND_IRCODE(String dev,int channel,String str)
Function: send IR Data

Parameters:

dev - : IR Equipment
channel - : Equipment Chanel number
str - : IR Data HEX String

Sample:

```

IR_M = M:1000; //define the IR device on the
controller's mother board
IR_M
// Send IR Code to the IR_M's first channel
// in which,
IRCODE<"StanderIRDb:3M:CODEC:VCS3000:P
OLYCOM1:6289:6 (MNO)"> are the IR Control
codes from 3M company in the IR Code database
// CODEC type,VCS3000 Model
number,POLYCOM1 equipment to be controlled,
IR Sample number 6289's MNO IR code
// Call the function and send out the matching IR
Code from the IR Code database
SEND_IRCODE(IR_M,1,IRCODE<"StanderIRDb:
3M:CODEC:VCS3000:POLYCOM1:6289:6
(MNO)">);

```

7.6.2.2 ON_RELAY

void **ON_RELAY**(String dev,int channel)
Function: turn on the relay module

Parameters:

dev - :relay device
channel - : device's channel number

Sample:

```

RELAY_M = M:1000:RELAY; // define the relay
with the motherboard number of 1000
ON_RELAY(RELAY_M,2); // turn on the relay
with the motherboard number of 1000

```

7.6.2.3 OFF_RELAY

void **OFF_RELAY**(String dev,int channel)
Function: turn off the relay

Parameters:

dev - : relay device
channel - :device channel number

Sample

```

RELAY_M = M:1000:RELAY; //define the
relay with the motherboard number of 1000
OFF_RELAY(RELAY_M,2); // turn off the relay
with the motherboard number of 1000

```

7.6.2.4 SET_COM

```
void SET_COM(String dev,
              int channel,
              long sband,
              int databit,
              int jo,
              int stopbit,
              int dataStream,
              int comType)
```

Function: Setup the COM interface

Parameters:

dev - :device name
channel - : Device channel number
sband - : Baud Rate
databit - : data bit 1~8
jo - : Parity 0: none,1: Odd number,2: even number,3: Mark,4: space
stopbit-: Stop bit 10,15,20, corresponding to 10=1,15=1.5,20=2
dataStream - : Data flow: 0: 无,1: xon/xoff,2: hardware

comType - : COM interface communication type 232,485,422; default value is 232

Sample:

```
Com_m = M:1000:COM; //define the COM
interface with the motherboard number of 1000
// setup the COM interface's first channel (i.e.
define the first COM interface with the
motherboard number of 1000)
// Baud rate is 9600,Data bit is 8,no parity, Stop
bit is 1,No data flow, communication type is 232
```

```
SET_COM(Com_m,1,9600,8,0,10,0,232);
```

7.6.2.5 SEND_COM

```
void SEND_COM(String dev,int channel,
String str)
```

Function: Com interface data sending

Parameters:

dev - : Com interface device
channel - :Device channel number
str - : Com interface data, support two formats:
1: Direct transmit string data (send the string as it is to the Com interface)
2: Conversion into Hex string (when it encounters string starting with 0x or 0X, the string will be converted into Hex format and be sent. For example: if 0x3132 is sent, the COM interface will receiver the string of "12").

Example:

```
Com_m = M:1000:COM; // define the COM
interface with the motherboard number of 1000
SEND_COM(Com_m,1,"1234"); // send the string
"1234" to the first channel of the mother board
SEND_COM(Com_m,1,"0x31323334"); // send
the string "1234" to the first channel of the
motherboard
```

7.6.2.6 SEND_IO

```
void SEND_IO(String dev,int channel,int val)
```

Function: Control I/O interface

Parameters:

dev - : io device
channel - :Device channel number
val - : data 0 | 1

Example:

```
Io_m = M:1000:IO; // define the I/O interface with
the mother board number of 1000
SEND_IO(Io_m,1,0); // output low electrical level
to the first channel of Io_m
```

7.6.2.7 READ_IO

```
int READ_IO(String dev,int channel)
```

Function: Control I/O interface

Parameters:

dev - : io device
channel - :Device channel number

Return: return the electrical level status of the "channel" in the I/O interface: it is 0 or 1. Other value is viewed as false.

Example:

```
io_m = M:1000:IO; // define the I/O interface with
the mother board number of 1000
int iostate =READ_IO(io_m,1); // read the first
channel's status of io_m
```

7.6.2.8 SEND_LITE

```
void SEND_LITE(String dev,int channel,int val)
```

Function: Control the lighting

Parameters:

dev - :Lighting device
channel - :Device channel number
val - : Analog value(Note: the analog value range is 0 - 65535)

Example:

```
lite_n = N:8:LITE; // define the lighting device with
the CR-NET number of 8
SEND_LITE (lite_n,1,65535); // send analog
value of 65535 to the first channel of lite_n
```

7.6.2.9 SEND_DM512

Void

```
SEND_DM512(String dev,int channel,int val)
```

Function: Control DMX512

Parameters:

dev - :lighting device
channel - :Device channel number
val - : Analog value(Note: the analog value range is 0 - 65535)

Example:

```
liit_L = L:7:DMX512; // define the DMX512 device
with the CRLINK(CAN) number of 7
SEND_DM512(liit_L,1,65535);// send the
analog value of 65535 to the first channel of liit_L
```

7.6.2.10SEND_ACAR

```
void SEND_ACAR(String dev,int channel,int val)
```

Function : Control the voltage output put of the conversion Card

Parameters:

dev - :Conversion Card device
channel - :Device channel number
val - : Analog value (Note: get the value according the actual external device. The general range is -12V ~ 12V of double type)

Example:

```
acar_L = L:7:ACAR; // define the ACAR device
with the CRLINK(CAN) number of 7
SEND_ACAR( acar_L,1,-12);// send analog value
-12 to the first channel of liit_L, i.e., set the
Conversion Card's output to -12V
```

7.6.2.11SEND_QACAR

```
Void SEND_QACAR (String dev,int channel)
```

Function : Send the request for the Conversion Card's voltage value. After the request being sent out, the Data EVENT of the Conversion Card will be triggered, and the voltage value will gotten there. For the detailed example, please refer to the other functions' BYTES_TO_INT

Parameters:

dev - : Conversion Card Device
channel - :Device channel number

Example:

```
Acar_m = M:8:ACAR; //Define the Conversion
Card with the motherboard number of 8
SEND_QACAR (Acar_m,1); //Read the voltage
value of the first channel of the Acar_m
```

7.6.2.12 ON_VOL

```
void ON_VOL(String dev,int channel)
```

Function: Turn on the volume

Parameters:

dev - :Sound controlling device
channel - :Device channel number

Example:

```
vol_N = N:9:VOL; // define the sound controlling
device with the CR-NET device number of 9:
vol_N
```

ON_VOL(vol_N,1); // turn on the first channel of vol_N

7.6.2.13 OFF_VOL

void OFF_VOL(String dev,int channel)

Function: Turn off the volume

Parameters:

dev - :Sound controlling device

channel - :Device channel number

Example:

vol_N = N:9:VOL; // define the sound controlling device with the CR-NET device number of 9:
vol_N ON_VOL(vol_N,1); //turn off the first channel of vol_N

7.6.2.14 SET_VOLTOTOL

void

SET_VOLTOTOL(String dev,int channel,int val)

Function: Control the overall volume

Parameters:

dev - :Sound controlling device

channel - :Device channel number

val - : Analog value (Note: this analog value's range is 0 - 65535)

Example:

vol_N = N:9:VOL; // define the sound controlling device vol_N with the CR-NET device number of 9
SET_VOLTOTOL(vol_N,1,600);//Set vol_N's first channel volume to 600

7.6.2.15 SET_VOLHIGHT

void

SET_VOLHIGHT(String dev,int channel,int val)

Function: Control the high-pitch part

Parameters:

dev - :Sound controlling device

channel - :Device channel number

val - : Analog value (Note: this analog value's range is 0 - 65535)

Example:

vol_N = N:9:VOL; // define the sound controlling device vol_N with the CR-NET device number of 9
SET_VOLHIGHT (vol_N,1,600);// Set the high-pitch part of the vol_N's first channel volume to 600

7.6.2.16 SET_VOLLOW

void

SET_VOLLOW(String dev,int channel,int val)

Function: Control the low-pitch part

Parameters:

dev - : Sound controlling device

channel - :Device channel number

val - : Analog value (Note: this analog value's range is 0 - 65535)

Example:

vol_N = N:9:VOL; // define the sound controlling device vol_N with the CR-NET device number of 9
SET_VOLLOW (vol_N,1,600);// Set the low-pitch part of the vol_N's first channel volume to 600

7.6.2.17 UP_WM

void UP_WM(String dev,int channel)

Function: Send "bounce back" command to the wall-mounted control keypad, applied for the communication when there is touch panel and the wall-mounted control keypad controlling the same device

Parameters:

dev - :wall-mounted control keypad device

channel - :Device channel number

Example:

wm_N = N:14:WM; // define the wall-mounted control keypad device with the CRNET device number of 14

UP_WM(wm_N,1);// set wm_N device's first channel to be "bounced up" status

7.6.2.18 DOWMP_WM

void **DOWN_WM**(String dev,int channel)

Function: Send "pressed down" command to the wall-mounted control keypad, applied for the communication when there is touch panel and the wall-mounted control keypad controlling the same device

Parameters:

dev - : wall-mounted control keypad device
channel - :Device channel number

Example:

wm_N = N:14:WM; // define the wall-mounted control keypad device with the CRNET device number of 14

DOWN_WM(wm_N,1);// set wm_N device's first channel to be "pressed down" status

7.6.2.19 DEV_REG

void **DEV_REG**(String dev, int channel)

Function: Device registration, mainly applied for the registration of the second generation wall-mounted control keypad

Parameters:

dev – input device
channel - :Device channel number

Example:

wm_N = N:14:WM; // define the wall-mounted control keypad device with the CRNET device number of 14
DEV_REG(wm_N,1);//register the first channel of the wm_N

7.6.2.20 DEV_QUERY

void **DEV_QUERY**(String dev, int channel)

Function: Device inquire , mainly applied for inquiring the second generation wall-mounted control keypad

Parameters:

dev – input device
channel - :Device channel number

Example:

wm_N = N:14:WM; // define the wall-mounted control keypad device with the CRNET device number of 14

DEV_QUERY (wm_N,1);//inquire the first channel of wm_N

7.6.2.21 Other functions

Many other functions have been provided to realize various controlling requirements. Hereby below are some brief introductions:

TRACE

Function: print the message msg

START_TIMER

Function: start the time with the name of "name" at the time interface of "time" milliseconds
This function is used together with
CANCEL_TIMER(XXX)

START_TIMER

Function: at the time of "year, month, day, hh, minute, second", start the time with the name of "name" at the time interface of "time" milliseconds .

CANCEL_TIMER

Function: Cancel the timer with the name of "Timer".
This function is used together with
START_TIMER(XXX,t)

WAIT

Function : Similar to the SLEEP function: delay the execution of the code block within the WAIT to certain time (the minimum unit is milliseconds)

The difference from the SLEEP function is: this code block will not affect other operations on the touch panel.

CANCEL_WAIT

Function: Cancel the WAIT with the name of "name"

SLEEP

Function : Delay the execution for some time

BYTES_TO_STRING

Function : Convert bytes to string

STRING_TO_BYTES

Function : Convert string to bytes

STRING_EQ

Function : Compare two strings, case sensitively

STRING_EQNOCASE

Function : Compare two strings, case ignored

STRING_STARTWITH

Function: compare the head of the strings

STRING_ENDWITH

Function: Compare the ends of the strings

ATOI

Function: Convert character type to int type

ITOA

Function: Convert the int type to String

BYTES_ADD

Function: Add parameter 2 onto parameter 1's end to form a new bytes and return the value

GET_BYTES_LENGTH

Function: get the length of the dynamic character array

BYTES_TO_HEX

Function: convert the dynamic character array to string of Hex format

HEX_TO_BYTES

Function: convert the Hex format string to dynamic character array

GET_YEAR

Function: get the year value of the system

GET_MONTH

Function: get the month value of the current system

GET_DATE

Function: get the day value of the current system

GET_HOUR_OF_DAY

Function: get the hour value of the current system

GET_MINUTE

Function: get the minute value of the current system

GET_SECOND

Function: get the second value of the current system

GET_DAY_OF_WEEK

Function: get which day is it today in a week of the current system

INT_TO_DOUBLE

Function: convert int to double type

DOUBLE_TO_INT

Function: convert double type to int type

STRING_TO_DOUBLE

Function: convert string type to double type

DOUBLE_TO_STRING

Function: convert double type to string type

7.7 Programing

In the following section, we will take the example of controlling a DVD with the touch panel through IR:

7.7.1 Build a new project

Launch the Think Control 1.0 software. Choose:

“File” – “New” or: click the icon  on the tools menu to build a new project, shown as the following dialog:

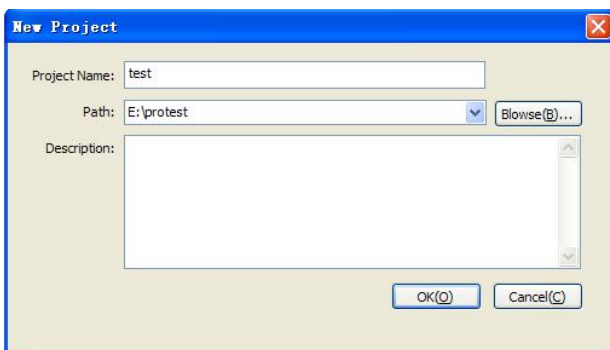

Type in the project name “test”, and click “browse” to set the saving location. Fill in other project information if necessary, and click “OK” to finish.

As we all know, all software are based on hardware, The object of the CR-PGMIII’s program is hardware, and to program for the CR-PGMIII is to set up how to drive, control and arrange all the hardware in the system to fulfill the required controlling functions.

Thus, to set up the hardware platform is the first

step of programming for the CR-PGMIII.

The software interface is as following:

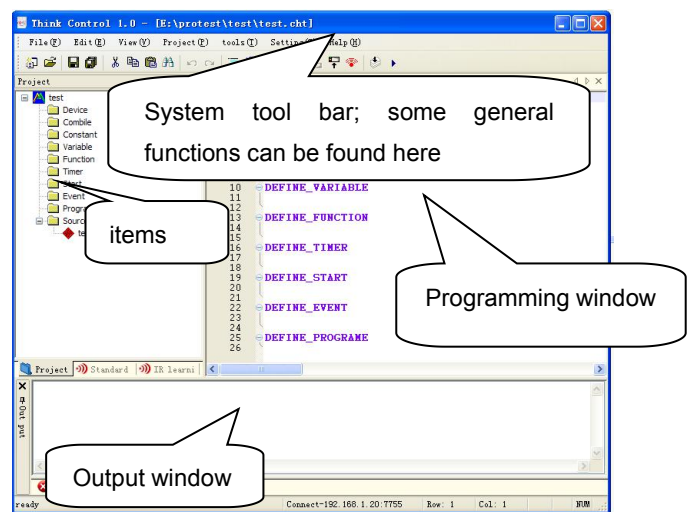

7.7.2 Add device

We need to add the devices before programming the project.

Select from the menu: “Items” – “add device” or

click the icon  to add devices.

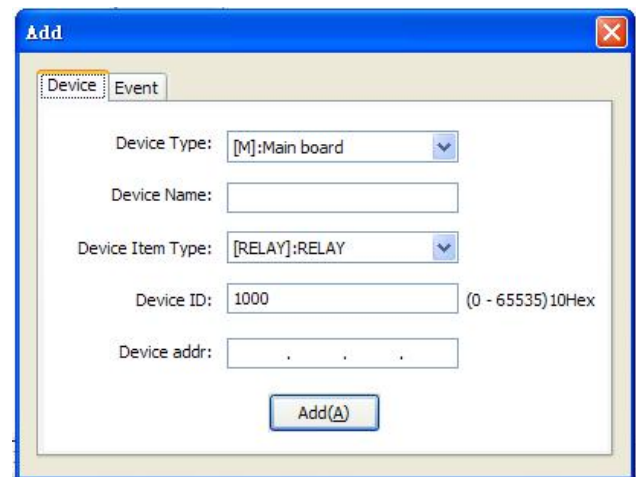

7.7.2.1 Device name

The device name can consist of alphabet letters, numbers and _ character, and can only start with a alphabet character or the _ character. The length of the device name is not limited, but generally they should be kept in reasonable length.

7.7.2.2 Device Type

The device type refers to the devices based on a mother device, and these devices include:

| Device Type | Description |
|-------------|-------------------------------|
| M | Main Controller's Motherboard |
| T | Touch Touch panels |
| N | CRNET devices |
| L | CRLINK devices |

7.7.2.3 Device ID

Each network device has its own ID, consist of 2 bits Hex format number respectively in H and L position. Any set up network device has a unique ID to be identified. When configuring the network devices, the devices' ID should be the same as the hardware's ID. And the network device ID in the program is by default in descending order numbers. Thus, adjusting their IDs in the software might be necessary to ensure their match with the hardware's ID, or, the devices cannot be controlled.

7.7.2.4 Device Parameter Type

It refers to the small devices on the carrier devices, such as the COM interfaces, lighting control device, and sound control device, etc.

| Device Parameter Type | Description |
|-----------------------|-----------------------------|
| RELAY | Relay |
| COM | COM Interface |
| TP | Touch panel |
| IR | Infra Red |
| IO | Input/Output Interfaces |
| LITE | Lighting Control Module |
| VOL | Sound Control Module |
| WM | Wall-mounted Control Keypad |
| DMX512 | 512 Lights |

For example: We need to control the built-in relay on the controller: type in the device name to be controlled: e.g. "relay_M"; select the device type: "[M]:Main "; type in the device ID, e.g. "1000";

then choose the device parameter type: "[RELAY]".

As we are going to control with the touch panel and the CR-PGMIII, thus, they also need to be added:

Add CR-PGMIII : Device type: [M]:Main, Device name : DVD_M, Device parameter type : [IR], device ID: 1000; as shown in the following image:

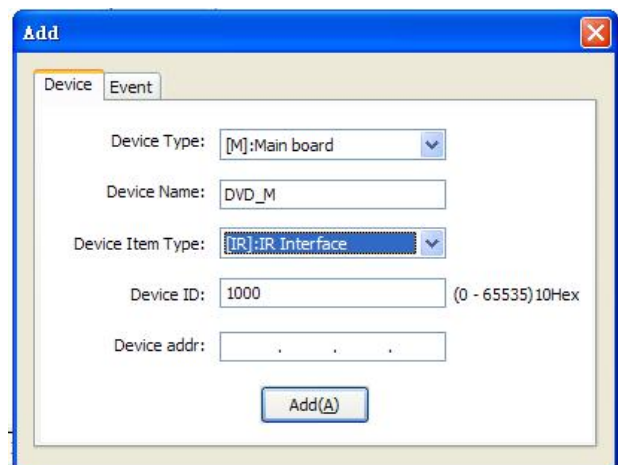

Click "add" to finish.

Then, we add the touch panel: [T]:Touch panel device type, device name: tp_1, device parameter type: [IR]:

The touch panel with the ID of 10 has been added as shown in the following image:

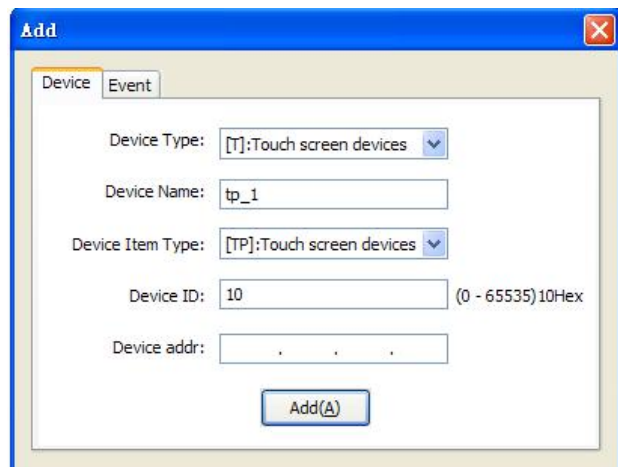

Click "add" to finish.

Then, we can find two lines of codes have been

required, click “no channel number”.

added into the editing area under the DEFINE_DEVICE:

```

1  DEFINE_DEVICE
2  DVD_M = M:1000:IR;
3  tp_1 = T:10:TP;
4
5
6  DEFINE_COMBINE
7
8
9  DEFINE_CONSTANT
10
11
12  DEFINE_VARIABLE
13
14
15  DEFINE_FUNCTION
16
17
18  DEFINE_TIMER
19

```

Added

Device define syntax:

Device name = [carrier device type]:[carrier device ID]:[device type]

7.7.3 Add event

After adding the devices, we need to consider: what we need to the control system to do:

Click the “add event” icon on the tools bar:



Add event

The touch panel devices’ channel numbers are their joint numbers.

Click to choose the necessary event functions in the “Options” tab:

- PUSH: Press down the button
- RELEASE: Release the button .
- HOLD: Set the time interval and repeat
- REPEAT: The operation to be done when the button is pressed down and held

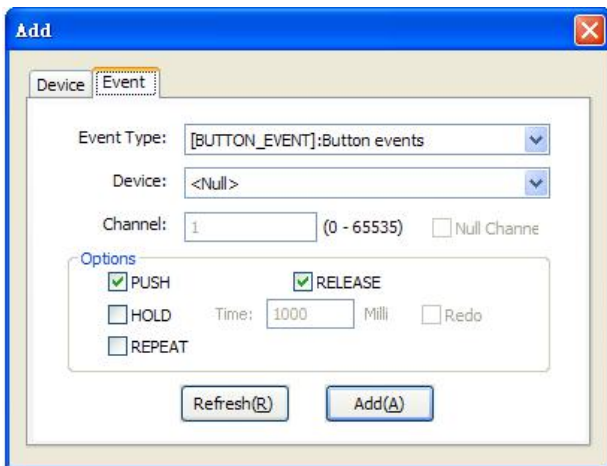
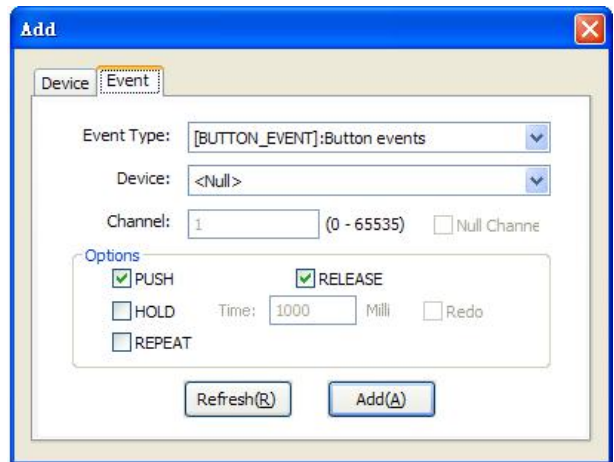

7.7.3.2 Bar event

Choose the “Event type” as “[LEVEL_EVENT]: bar event

Choose a device from the drop-down menu, and it can also be chosen as “none”.

Choose the target button’s number in the “channel” box. If the channel number is not required, click “no channel number”.

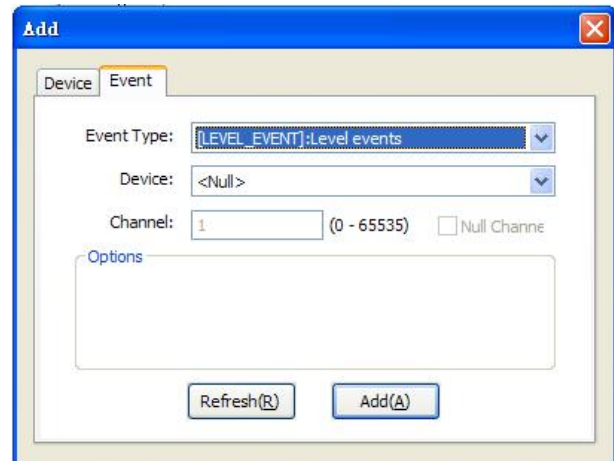

7.7.3.1 Button event

Choose “Event type” “[BUTTON_EVENT]”
 Choose a device from the drop-down menu: e.g. “tp_1”, “none” can also be chosen. .
 Choose the target button’s number in the “channel” box. If the channel number is not

7.7.3.3 Data Event

Choose the “Event type” as “[DATA_EVENT]:”

Choose a device from the drop-down menu or choose “none”.

Choose the channel number after the “Channel” option. As for COM interface, the channel number here is used to identify different COM interfaces. For example: if we choose the channel number to be 1 after defined the Com interface on the motherboard of the controller, it means the first COM interface of the CR-PGMIII.

Click to choose the necessary event functions in the “Options” tab:

ONLINE: the operations to be done after received the data online command from the device

OFFLINE: the operation to be done after received the data offline command from the device

ONERROR : the operation to be done after received the error information from the device

ONDATA: the operation to be done after received data from the device

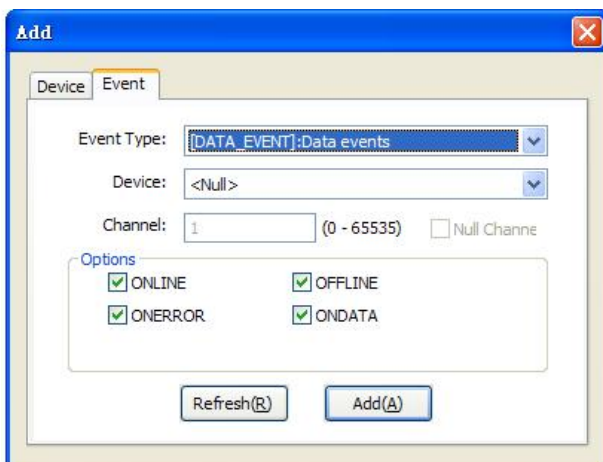

We add button even here. (Generally we need to add more than one button event.)

Then we can find the BUTTON_EVENT function under the DEFINE_EVENT in the editing area.

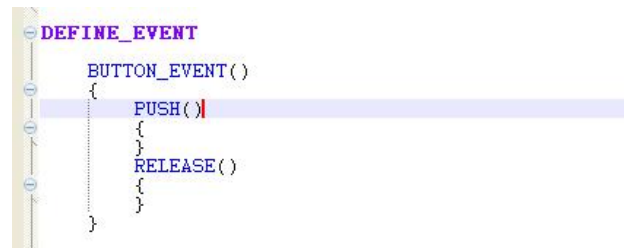

7.7.4 IR Learning

7.7.4.1 IR Learning

To control IR devices, their IR control codes need to be collected firstly. And this procedure is called “IR Learning”, and it is different between different controllers.

There is a built-in IR Learning Module in the CR-PGMIII. What needs to be done is only to press the respective buttons on the remote facing the IR Learning Module, the Sensor on the CR-PGMIII, and the IR Control codes will be learnt and stored into our PC into a cir file.

The procedure can be done with the IR Learning Management Tool named “IRL” in the Think Control 1.0 software.

7.7.4.2 IRL Tool

IRL is a tool in the Think Control 1.0, used for collecting the IR Control Codes from the devices, and upload them into the CR-PGMIII along with the program.

Click the icon from the tools bar to launch the IRL tool, shown as below:



◆ Set the IR connection IP

First connect the CR-PGMIII to the PC with the network cable. After launching the IRL, type in the CR-PGMIII’s IP address and port number, then click “Apply”. (The default IP of the CR-PGMIII is 192.168.1.20, the port number is fixed as 100)

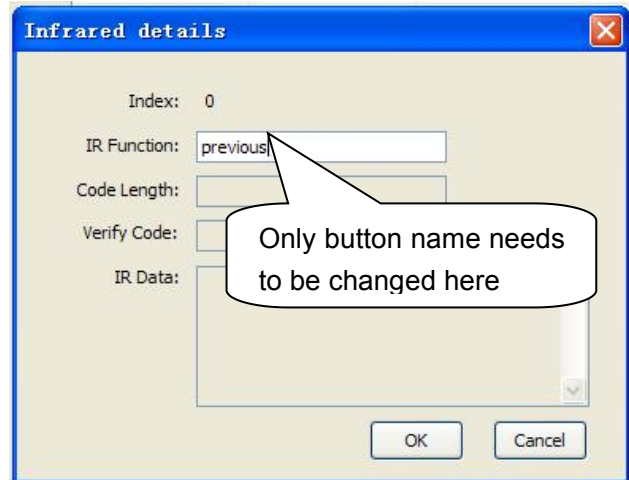
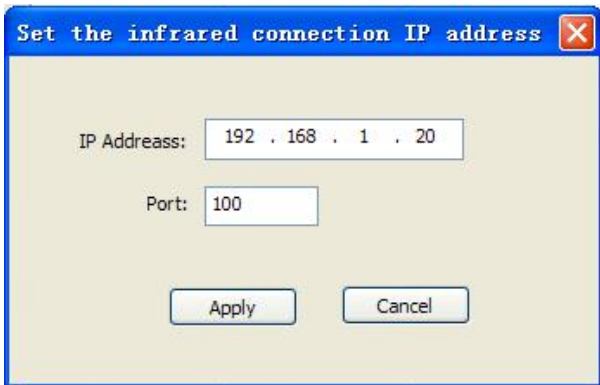

◆ **Built new IR file**

Click the icon  on the tools bar, or click “File” – “New” to build a new file. Fill in the relevant information in the pop up dialog:

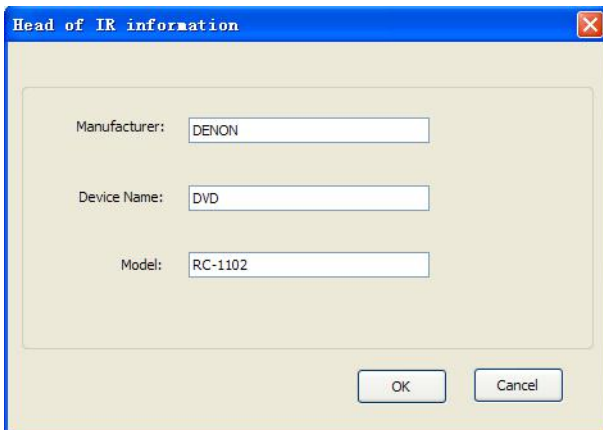

Click OK to finish

◆ **Add control buttons**

We need to add the control buttons to the newly built blank file. Taking the DVD control as the example:

Click  or click “IR Database”—“Add IR Control Code” to bring out a pop out dialog. A name of the button should be assigned for easy deification.

Following the above mentioned procedures to add other IR codes.

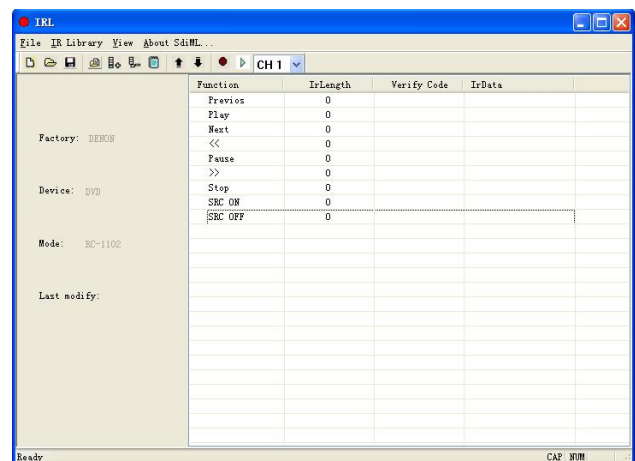

◆ **Choose the IR output channel**

This is to select the channel through which the IR Control codes will be sent out from the CR-PGMIII.

Click the CH1 on the tools bar to bring out the drop down menu. There are 8 channels available for option, as shown in the following image:

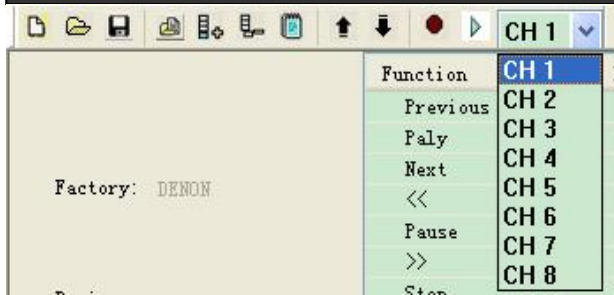

◆ IR Control Codes Collection

Make sure the connection between the PC and the CR-PGMIII is through before learning the IR control code.

Long codes and Short codes:

The CR-PGMIII supports learning both the Long Codes and the Short Codes. The Short Codes are more common: for example, the PLAY, POWER and PAUSE buttons etc. for DVD control are all of Short Codes. The Long Codes are rarely seen: the most typical case is volume control in some devices, under which circumstances, if the Short Codes are used, a very little margin will be adjusted for each press and this can bring lots of inconvenience. To solve this problem, the CR-PGMIII supports Long Codes learning functions, which brings lots of easiness to the controlling operations.

Within this example, all codes to be learnt are Short Codes.

The general procedures will be:

Click the IR Learning button in the software, then the software will wait for the IR Codes input, and the red indicator on the front panel of the CR-PGMIII will also start to flash. Within 10 seconds after clicked the IR Learning button in the software, press the corresponding control button on the device's remote and point it to the IR Learning Module of the CR-PGMIII. After press the button on the device's remote, the software will ask whether you need to save the collected IR Control Code. Click "Yes" to save the IR Control Code into the cir file on the PC. Then, the software will ask whether you need to learn the next IR Control Code. After all the buttons'

corresponding IR codes have been learnt, the software will pop up "Cancel" to exit the IR Learning procedure, and all the collected IR Control codes will be saved in the cir file in the PC.

Taking learning the IR codes for the DVD as our example:

A: Click the  on the tools bar to launch the IR learning tool, or single click "IR Database" – "IR Learning".

B: The following dialog will pop up:

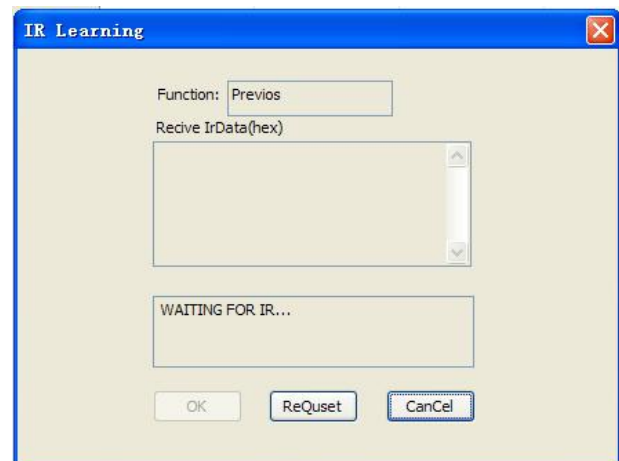

C: When this dialog shows up, it means we can collect the IR Control Codes from the device's remote now: press down corresponding control button on the device's remote and point it to the IR Learning Module of the CR-PGMIII. Then the following dialog will pop up:

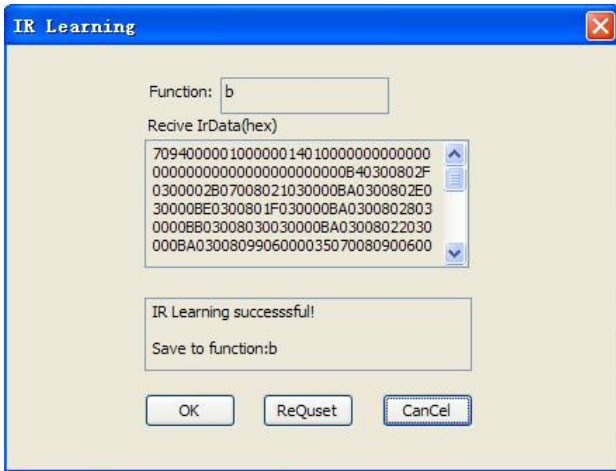

D: Click OK to save and the software will ask whether you need to record for the next button:

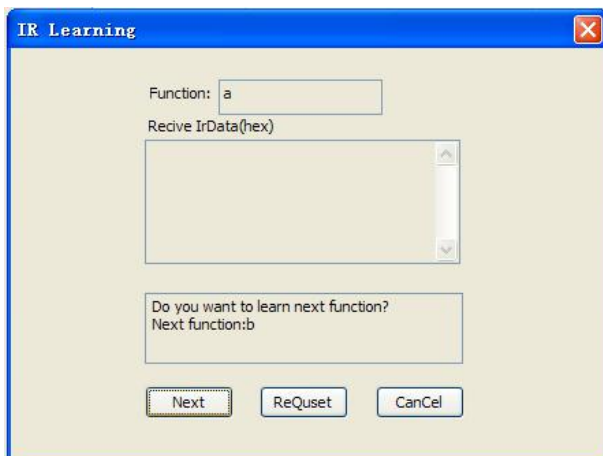

E: Click OK to collect the IR Control code for the next button, till all the needed IR codes have been learnt, then press “cancel” to exit.

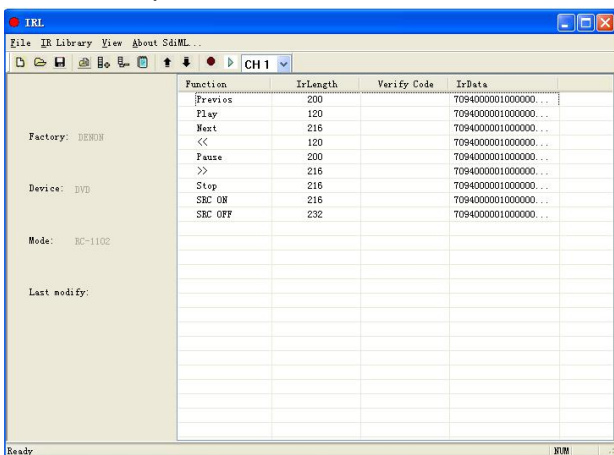

Note:

◆ During collecting the IR Control Code, the device’s remote needs to face right to the IR Learning Module on the controller, and the distance should be 3~5 cm.

◆ When pressing the device’s remote buttons, the time should not be too long, rather, you should perform as general operations to control the IR device with its remote.

◆ Special attention should be paid when collecting the UP, DOWN, LEFT and RIGHT navigation keys: the time should be short when press the control buttons on the device’s remote.

◆ Must be sure that every added button in the software has its recorded IR Control code, and the unnecessary buttons need to be deleted.

7.7.5 Import IR Control Codes

Click the Think Control 1.0’s “View” on the tools bar, and click the IR Database, as shown in the following image:



Right click at the blank area, and choose IPM at the pop up menu, then the following dialog will show up: choose the cir file learnt just now to open: as shown below:

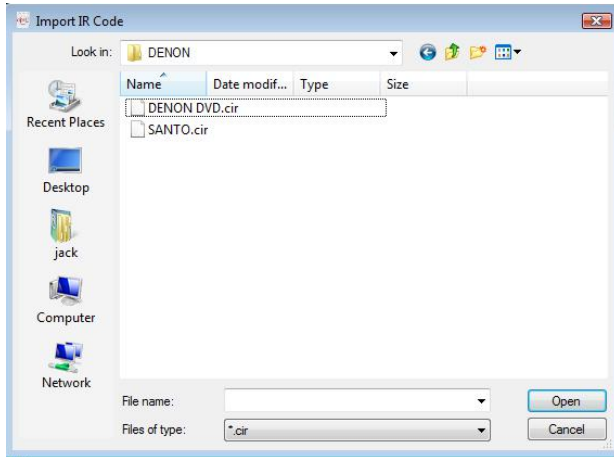

After successful import, we can see our learnt IR control codes in the IR Control Codes Database, as shown in the following image:

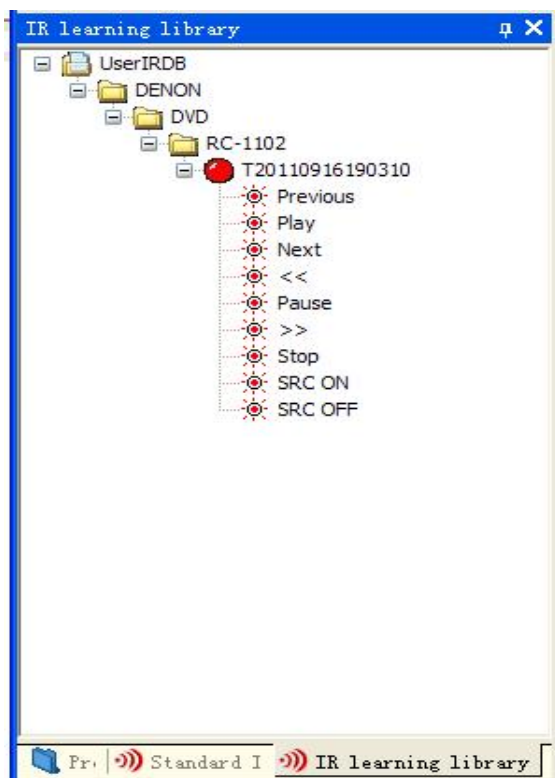

7.7.6 Editing the program

After finishing all the above configuration steps, we need start the programming stage

We want the controller to send out IR control code for PLAY when we press down tp_1's JOBMONBER 1 button, and send out IR control code for PAUSE when we press down tp_1's JOBMONBER 2 button.

Hereby we need to use the function SEND_IRCODE () to send out the IR control codes.

The program is as following:

```

BUTTON_EVENT(tp_1,1)      // tp_1 touch
panel's JointNumber1
{
    PUSH()
    {
        //send out IR control code for PLAY from
DVD_M
        SEND_IRCODE(DVD_M,1,
IRCODE<"UserIRDb:DENON:DVD:RC-1102
:T20110225093436:Play");
    }
    RELEASE()
    {
    }
}
BUTTON_EVENT(tp_1,2)      //tp_1 touch
panel's Jointnumber 2
{
    PUSH()
    {
        // send out IR control code for PAUSE
from DVD_M's IR channel 2
        SEND_IRCODE(DVD_M,2,
IRCODE<"UserIRDb:DENON:DVD:RC-1102:
T20110225093436:Pause">);
    }
    RELEASE()
    {
    }
}
}

```

7.7.6.1 How to insert IR Control code

You can choose the required IR Control code from the IR Control Codes database to insert into the program rather than typing in.

A: Firstly, move the cursor to the place to insert the IR Control code

```

23
24 DEFINE_EVENT
25
26     BUTTON_EVENT(tp_1, 1)
27     {
28     {
29     {
30     { SEND_IRCODE(DVD_M, 1.)
31     {
32     { RELEASE()
33     {
34     {
35     {
36     {
    
```

B: Choose the required IR Control Code from the data base and double click. And it's done.

7.7.7 Compile the project

After writing the program and before we upload the program into the controller, we need to compile the program.

Click the "Compile" button as shown below:

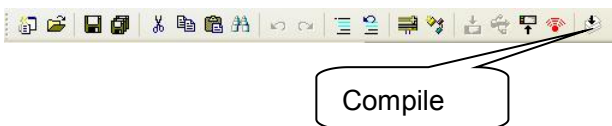

When compiling, the detailed information will be shown in the "Output" window:

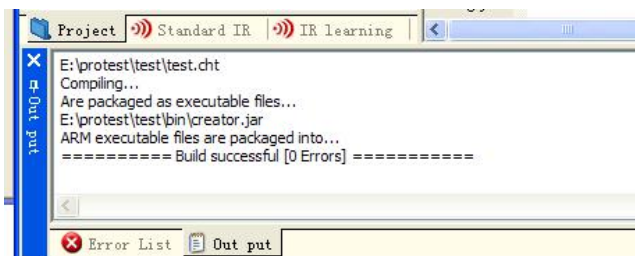

If some error happens, the software will jump to the "Error Window". Double click the error information will bring you to the corresponding

codes which caused the error;

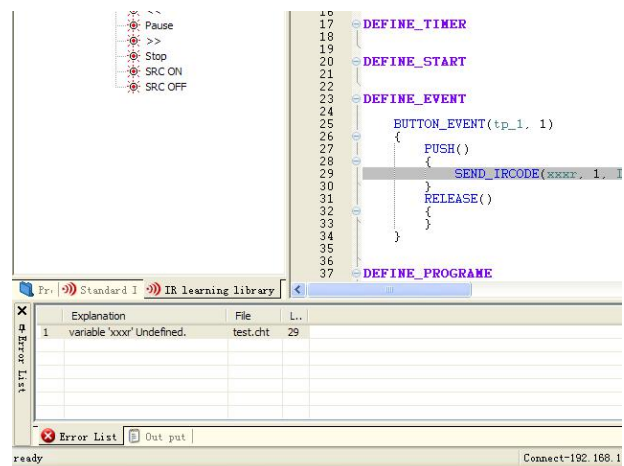

Then a CR-PGMIII has been finished.

7.8 Upload the program to the CR-PGMIII

After successfully compiled the program, click the below shown icon to launch the DManger software:



1, Click the button as shown below:



2, Set up the controller's IP:

Controller IP: by default it is 192.168.1.20

Port: fixed as 7755

Click Apply to finish.

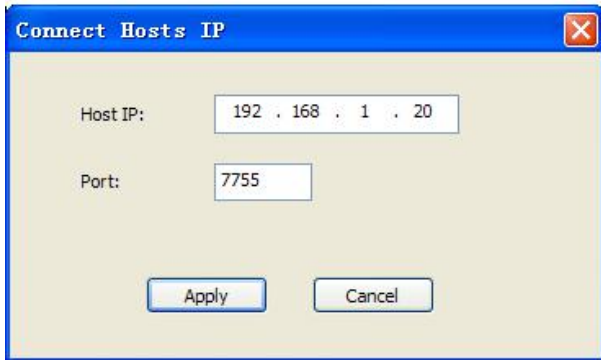

Please be noted that the controller’s IP cannot conflict with the PC’s IP.

3. Choose “Network Control” --- “Upload to 0



controller ” or click the icon and choose the program in the pop up dialog, as shown below:

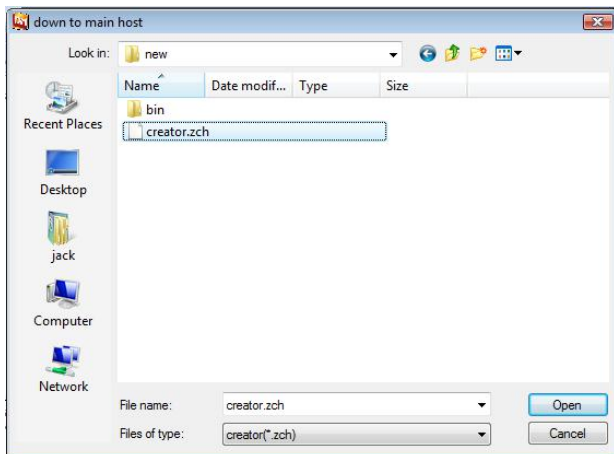

4. Click “open” to upload the program to the controller.

If the operation is successful, a window will appear as below:

Successful file transfer!
Update host Successful !

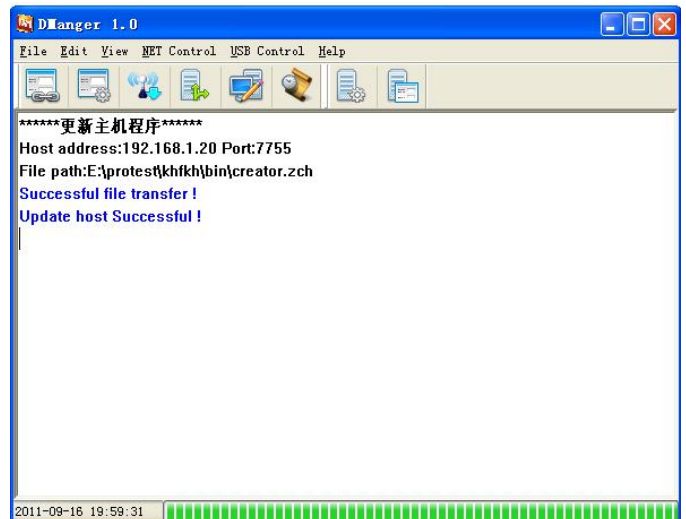

If it is unsuccessful, repeat the above procedures 2 ~ 4 to upload the program again

If it is not the first time uploading the program to the controller, and the controller is well connected to the PC, you can click the upload icon on the tools bar to upload the program, rather than repeating the above mentioned steps.



Network uploading

7.9 Project Sample

Here below are some sample projects for your reference:

7.9.1 Control the built-in relay modules on the controller

```
tp = T:1000:TP; //define the tp with the ID of 1000
```

```
m_relay = M:1002:RELAY; //define the built-in replay on the controller: m_relay
```

DEFINE_EVENT

```

BUTTON_EVENT(tp,1)
{
    PUSH()
    {
        ON_RELAY(m_relay,1); // turn on the first way of relay modules
    }
}
    
```

```

}

BUTTON_EVENT(tp,2)
{
    PUSH()
    {
        OFF_RELAY(m_relay,1); // turn off
the first way of the relay module
    }
}

BUTTON_EVENT(tp,3)
{
    PUSH()
    {
        ON_RELAY(m_relay,2); //turn on
the second way of the relay module
    }
}

BUTTON_EVENT(tp,4)
{
    PUSH()
    {
        ON_RELAY(m_relay,2); // turn off
the 2 way of the relay module
    }
}

BUTTON_EVENT(tp,5)
{
    PUSH()
    {
        ON_RELAY(m_relay,3); //turn on
the 3 way of the relay module
    }
}

BUTTON_EVENT(tp,6)
{
    PUSH()

```

```

{
    ON_RELAY(m_relay,3); // turn off
the first way of the relay module
}
}

```

7.9.2 Cascading and Module calls

DEFINE_DEVICE

```

tpx = T:1002:TP;
mtp = M:0:TP;
com = M:1003:COM;
mr = M:1000:IR;
io = M:1000:IO;
tp7600 = N:07100:TP;
acar = L:12:ACAR;

```

DEFINE_COMBINE

```
[tpx,mtp];
```

DEFINE_EVENT

```

// receive the data from the first COM
interface and send it to the second COM interface
DATA_EVENT(com ,1)
{

```

```

    ONDATA()
    {
        SEND_COM(com,2,"0x" +
BYTES_TO_HEX(DATA.Data));
    }
}

```

```

BUTTON_EVENT(tpx,12)
{
    PUSH()
    {
        SEND_ACAR(acar,1,12);
        SEND_ACAR(acar,1,12);
    }
}

```

```

LEVEL_EVENT(tp7600,1)
{

SEND_M2M_LEVEL("192.168.1.10",2,LEVE
L.Value);

SEND_M2M_LEVEL("192.168.1.2",12,LEVE
L.Value); // send the touch panel's bar data 13
with the joint number of 12 to the controller with
the IP of 192.168.1.2
}

BUTTON_EVENT(tp7600,1)
{
    PUSH()
    {

SEND_M2M_DATA("192.168.1.2","11111");
//send character 11111 to the controller with the IP
of 192.168.1.2

SEND_M2M_JNPUSH("192.168.1.2",12); //
send the touch panel's joint number 12 to the
controller with the IP of 192.168.1.2
SEND_M2M_JNRELEASE("192.168.1.2",12

);// send release command of the touch panel's
joint number 12 to the controller with the IP of
192.168.1.2

        //
    }

}

// send the data of the 2nd way of the COM
interface to the controller with the IP of
192.168.1.10
DATA_EVENT(com,2)
{
    ONDATA()
    {

SEND_M2M_DATA("192.168.1.10",BYTES_
TO_STRING(DATA. Data));
    }
}

M2MDATA_EVENT()
{
    ONDATA()
    {
        TRACE("all
ip:"+DATA.STR_M2MIPADDR +" data:" +DATA.
Data String);
    }
}

M2MDATA_EVENT("127.0.0.1")
{
    ONDATA()
    {
        TRACE("dai                ip
ip:"+DATA.STR_M2MIPADDR +" data:" +DATA.
DataString);
        int p = DATA.B1;
        string ip =

DATA.STR_M2MIPADDR;
    }
}

M2MDATA_EVENT("127.0.0.11")
{

    ONDATA()
    {

}
}

DEFINE_CALL_TEMPLATE
abc(tpx,3,5,com,4);

```

7.9.3 Wall-mounted Programmable keyboard

DEFINE_DEVICE

```
CRNET_RELAY= N:6:RELAY;
```

```
//define relay with the ID number of 6
```

```
CRNET_WallBoard = N:9:WM; //define
```

the wall-mounted programmable keyboard with the ID of 9

DEFINE_EVENT

// the wall-mounted programmable keyboard's (CRNET_WallBoard) first way return data is to control ON/OFF of the relay: CRNET_RELAY

//correspond to the DATA of the wall-mounted programmable control keyboard. Data[0]==1 means being pressed down; == 0 means bouncing back; DATA. Data is the returned character array.

```
DATA_EVENT(CRNET_WallBoard,1)
```

```
{
```

```
  ONDATA()
```

```
  {
```

```
    TRACE("recive data from zhu gong");
```

//////DATA. Data is returned character array from the com port//Note: currently

doesn't support 0x8 display

```
  if(DATA. Data[0]==1)
```

```
  {
```

```
    ON_RELAY(CRNET_RELAY,1);
```

```
      //ON_VOL(CRNET_VOL_01);
```

```
    //SET_VOLTOTOL(CRNET_VOL_01,"56666");
```

```
  }
```

```
  else if(DATA. Data[0]==0)
```

```
  {
```

```
    OFF_RELAY(CRNET_RELAY,1);
```

```
  }
}
```

```
}
```

```
//same as above, the 2nd way
```

```
DATA_EVENT(CRNET_WallBoard,2)
```

```
{
```

```
  ONDATA()
```

```
  {
```

```
    TRACE("receive data from zhu gong");
```

//DATA. Data is the returned data from the COM interface, displayed in character array. Note: 0x8 is not supported currently

```
    if(DATA. Data[0]==1)
```

```
    {
```

```
      ON_RELAY(CRNET_RELAY,2);
```

```
        //ON_VOL(CRNET_VOL_01);
```

```
      //SET_VOLTOTOL(CRNET_VOL_01,"56666
```

```
    }
```

```
    else if(DATA. Data[0]==0)
```

```
    {
```

```
      OFF_RELAY(CRNET_RELAY,2);
```

```
    }
```

```
  }
```

```
//same as above, 3rd way
```

```
DATA_EVENT(CRNET_WallBoard,3)
```

```
{
```

```
  ONDATA()
```

```
  {
```

```
    TRACE("recive data from zhu gong");
```

//DATA. Data is the returned data from the COM interface,

```

displayed in character array. Note: 0x8 is
not supported currently
    if(DATA. Data[0]==1)
    {
        ON_RELAY(CRNET_RELAY,3);
    }
    else if(DATA. Data[0]==0)
    {
        OFF_RELAY(CRNET_RELAY,3);
    }
}
}

```

7.9.4 Lighting and Sound Control

DEFINE_DEVICE

```

tp_1 = T:20:TP; // define the touch panel
device with the ID of 20
CRNET_VOL = N:4:VOL; //define the
sound control device with the CRNET ID of 4
CRNET_light = N:5:LITE; //define the
lighting control device with the CRNET ID of 5

```

DEFINE_VARIABLE

```

int cr_light; //define the brightness
variable of the CRNET lighting control device
int cr_vol; //define the volume
variables of the CRNET sound control device

```

DEFINE_EVENT

```

// between the time interval of pressing down
tp_1 buttons and bouncing up, the codes within
the REPEAT block will be executed repeatedly,
i.e., press to turn on the 1 way of the CRNET_
    BUTTON_EVENT(tp_1,52)
    {
        REPEAT()
        {
            cr_light=cr_light+100;

```

```

        if(cr_light>65535)
        {
            cr_light=65535;
        }

        SEND_LITE(CRNET_light,1,cr_light);
    }
}

// same as above, brightness reduce
BUTTON_EVENT(tp_1,53)
{
    REPEAT()
    {

        SEND_LITE(CRNET_light,1,cr_light);
        cr_light=cr_light-100;
        if(cr_light<0)
        {
            cr_light=0;
        }
    }
}

// same as above, brightness reduces
BUTTON_EVENT(tp_1,50)
{
    REPEAT()
    {

        SET_VOLTOTOL(CRNET_VOL,1,(cr_vol));

        SET_VOLTOTOL(CRNET_VOL,2,(cr_vol));
        cr_vol=cr_vol+100;
        if(cr_vol>65535)
        {
            cr_vol=65535;
        }
    }
}

```

```

// same as above, the general volume
reduces
BUTTON_EVENT(tp_1,51)
{
    REPEAT()
    {
        SET_VOLTOTOL(CRNET_VOL,1,(cr_vol));

        SET_VOLTOTOL(CRNET_VOL,2,(cr_vol));
        cr_vol=cr_vol-100;
        if(cr_vol<0)
        {
            cr_vol=0;
        }
    }
}

```

7.9.5 Interlock of 2 ways relay

DEFINE_DEVICE

```

RL_M = M:1000:RELAY;    //define the
built-in relay on the controller
tp_1 = T:10:TP;        //define the
touch panel with the ID of 10

```

DEFINE_EVENT

```

BUTTON_EVENT(tp_1,1)

{
    PUSH()
    {
        ON_RELAY(RL_M,1);
//turn on the first relay on the controller
        OFF_RELAY(RL_M,2);
//turn off the 2nd relay on the controller
    }
    RELEASE()
    {
    }
}
BUTTON_EVENT(tp_1,2)
{
    PUSH()
    {

```

```

ON_RELAY(RL_M,2);
//turn on the 2nd relay on the controller

        OFF_RELAY(RL_M,1);
//turn off the first relay on the controller
    }
    RELEASE()
    {
    }
}

```

7.9.6 Repeat button pressing without affecting delay timer execution

DEFINE_DEVICE

```

REL = N:8:RELAY;        //define the
CRNET relay with the ID of 8
tp_1 = T:10:TP;        //define the
touch panel device with the ID of 10

```

DEFINE_VARIABLE

```

int py=1;    //define the CRNET relay's
variables

```

DEFINE_EVENT

```

BUTTON_EVENT(tp_1,1)
{
    PUSH()

    {
        //turn on the CRNET relay's 1 way
        ON_RELAY(REL,1);
        //wait for 5 seconds, then turn off
the first way of the CRNET relay; repeat pressing
donw the button during the waiting time will not
affect the execution
        if(py==1)
        {
            py=0;
            WAIT 5000
            {
                OFF_RELAY(REL,1);
                py=1;
            }
        }
    }
}

```

```

    }
    RELEASE()
    {
    }
}

```

7.9.7 Control the matrix switchers

DEFINE_DEVICE

```

tp = T:10:TP;
mcom = M:1000:COM;

```

DEFINE_VARIABLE

```

string checkMode = "";
string outstr = "";

```

```

string instr = "";

```

DEFINE_FUNCTION

```

//matrix output function
void shuchu()
{
    SEND_COM(mcom,1,instr+checkMode+outs
tr+ ".");
}

```

DEFINE_START

```

SET_COM(mcom,1,9600,8,0,10,0,232);

```

DEFINE_EVENT

```

//choose the mode
BUTTON_EVENT(tp,4)
{
    PUSH()
    {
        checkMode = "B";//AVmode
    }
}

```

```

BUTTON_EVENT(tp,6)

```

```

{
    PUSH()

```

```

    {
        checkMode = "A"; //Amode
    }
}

```

```

BUTTON_EVENT(tp,5)

```

```

{
    PUSH()
    {
        checkMode = "V"; //Vmode
    }
}

```

```

//choose the output

```

```

BUTTON_EVENT(tp,1)

```

```

{
    PUSH()
    {
        outstr = "1";
    }
}

```

```

BUTTON_EVENT(tp,2)

```

```

{
    PUSH()
    {
        outstr = "2";
    }
}

```

```

BUTTON_EVENT(tp,3)

```

```

{
    PUSH()
    {
        outstr = "3";
    }
}

```

```

// select the input
BUTTON_EVENT(tp,11)

```

```
{  
    PUSH()  
    {  
        instr = "1";  
        shuchu();  
    }  
}
```

BUTTON_EVENT(tp,12)

```
{  
    PUSH()  
    {  
        instr = "2";  
        shuchu();  
    }  
}
```

BUTTON_EVENT(tp,13)

```
{  
    PUSH()  
    {  
        instr = "3";  
        shuchu();  
    }  
}
```

BUTTON_EVENT(tp,100)

```
{  
    PUSH()  
    {  
        SEND_COM(mcom,1,instr + "All.");  
    }  
}
```

Chapter Eight, Technical Specifications

| Function | CR-PGMIII |
|---------------------------------------|-----------------------|
| Memory | 256M DDR-RAM,1G FLASH |
| CR-NET,CR-LINK and Ethernet(TCP/IP) | Yes |
| Independent IR Emitting Interface | 8 ways |
| Digital I/O Interface | 8 ways |
| Low-current Relay Module | 8 ways |
| RS-232/422/485 Serial Ports | 8 ways |
| USB Interface | 1 ways |
| Extension Slot | Yes |
| Grounding Pole | Yes |
| Dimensions | 2U |
| Weight | About 4.5KG |
| AC100—240V Self-adaptive Power supply | Yes |

Chapter Nine, General Trouble Shootings

| Troubles | Solutions |
|---|--|
| Cannot control the device with the touch panel | <ul style="list-style-type: none"> • Check the touch screen's buttons' Joint Number whether match the assigned joint number in the CR-PGMIII's program. • Check the touch panel's ID whether matches the assigned ID in the CR-PGMIII's program. • Check the wireless AP's connection with the CR-PGMIII. • Check whether the wireless AP has been installed with antenna, and whether the touch panel is within the wireless AP's coverage. • Check whether the touch screen can control the devices near to the wireless AP. If not, either the touch panel or the wireless AP has some problem. Please contact the certified after sales person for repairing. |
| Cannot download the program to the touch screen from PC | <ul style="list-style-type: none"> • Check the USB connection. • Check the touch screen driver installation. • Check whether the touch panel's model is matching with the assigned model in the touch panel program. • Check the PC's USB interface. • Check the touch panel's power supply, and whether the touch panel can be turned on. |
| No display on the touch panel | <ul style="list-style-type: none"> • Recharge the touch panel. • Check the power supply connection to the touch panel while charging. • Check the touch panel battery installation, and try re-install the battery. |

Touch panel buttons don't response

- Try re-calibrating the touch panel.
- Check the touch panel program to see if the button has been drawn as text.
- Check the touch screen's battery status.

CREATOR CORPORATION (CHINA)
Copyright by CREATOR

Last Revision: 03/2011